



Pharma | Food | Biotechnology | Cosmetics

Sanitary applications



Smart in sensing



Alexander Wiegand, Chairman and CEO, WIKA

About us

The WIKA Group is a global market leader in pressure and temperature measurement. The company also sets the standard in the measurement of level, force and flow, and in calibration technology.

The broad portfolio of high-precision instruments, IIoT solutions and comprehensive services makes WIKA a strong and reliable partner for all the requirements of industrial measurement technology.

The family-run business, founded in 1946, has a global presence with 11,200 employees. This includes our own subsidiaries, production sites and development departments, such as the Innovation Center in Klingenberg.

There alone, over 100 engineers work on innovative sensing solutions that provide answers to global challenges. WIKA's unique experience and know-how make sensing technology smarter, add more value and prepare it for a sustainable future: Smart in sensing.

Contents

Hygienic design	4
Electronic pressure measuring instruments	10
Mechanical pressure measuring instruments	16
Diaphragm seals	20
Electrical temperature measuring instruments	27
Mechanical temperature measuring instruments	33
Gravimetric level measurement	34
Force measuring instruments	36
Level measuring instruments	38
Installation examples	41
Special applications	45
Service	46
WIKA worldwide	48

WIKA – Your partner for sanitary applications

In the manufacture of food and pharmaceuticals, safety in production and the prevention of any risks to those using the finished product is of the highest priority.

In the chain of all the process components within a plant, measurement technology plays a key role. Measurement technology delivers process-specific information which enables high-quality production. For this, the safety and hygienic requirements in the design of the measuring instruments and the connection of the sensors to the production plant must be fulfilled optimally with respect to ease of cleaning.

This brochure will assist you in selecting hygienic measuring instruments to solve pressure, temperature and level measurement challenges. In co-operation with you, we will develop tailored solutions geared to the individual requirements of your process.

Hygienic design

The hygienic design of plant components in contact with products is an essential prerequisite for avoiding microbiological contamination, and with that, ensuring product quality. As part of the overall hygienic concept of a plant, the measuring instruments used must comply with special requirements on material, surface quality, process safety, connection engineering and cleanability in the scope of the CIP process.

As a company member of the European Hygienic Engineering and Design Group (EHEDG), WIKA contributes to the international standards and combines hygienic design with high-quality measurement technology.



Materials

Austenitic stainless steel is used as a standard material for wetted areas. In the food and beverage industry and also in the pharmaceutical industry, 1.4404 and 1.4435 grades are preferred.

Stainless steels are inert to the majority of foods and pharmaceuticals, while also offering good corrosion resistance to disinfectants and cleaning agents. For specific applications, special alloys are used, such as the fully austenitic stainless steel, 1.4539 (904L), or Hastelloy C and Inconel. With diaphragm measuring instruments, we use the highly corrosion-resistant nickel-chromium alloy, 2.4668 (N07718), in order to achieve an optimal measurement performance with higher robustness.

As a standard material for all those metallic surfaces that will come into contact with the process medium, we use stainless steel 1.4435. For materials intended to come into contact with food, we can provide certification to this effect in accordance with regulation (EC) no. 1935/2004 and GB 4806.1-2016 National Food Safety Standard.

Surfaces

An important aspect in the cleaning of a plant using CIP/SIP processes is the quality of the surfaces in contact with the process medium.

To enable the easy cleaning of the measuring instruments, and also to prevent biofilms, the wetted surfaces must be passive and free from microscopic flaws. In addition to the surface topography, the surface roughness is an important criterion for cleanability. In the standards, such as EHEDG Doc. No. 8, "Hygienic equipment design criteria", a roughness of $Ra < 0.8 \mu\text{m}$ is considered as sufficient for normal cleaning processes.

For sensitive biotechnology processes, surfaces with a lower roughness are needed, e.g. $Ra < 0.38 \mu\text{m}$ electropolished or SF4 per ASME BPE.

Electropolishing

By using electrolytic polishing, the cleanability of the surfaces can be improved. In this way, essentially, the topographical structure of the surfaces is smoothed and therefore the roughness is decreased. A further advantage is that electropolishing increases the passive layer of stainless steel, and thus the corrosion resistance is improved, especially with reducing media.



Sealing materials

In the selection of suitable sealing material, various process parameters and also the process media are important. Sealing materials must be toxicologically harmless and sufficiently resistant to abrasion, be resistant against aggressive cleaning and disinfecting media, and be stable in superheated steam at high sterilisation temperatures.



Predominantly, special compounds are used for O-rings or form seals, for example fluororubber-based (FKM) such as VITON[®], ethylene-propylene-diene material (EPDM) or poly-tetra-fluoro-ethylene (PTFE). The materials used for the sealing elements, and also their manufacturing processes, must conform to the rules of the regulatory authorities and organisations.



Process connections

Process connections which are used in CIP-compatible equipment should not constitute any risk in respect to cleaning. They are characterised by the following features:

- A defined compression of the sealing element through a metallic stop
- Centring via a cylindrical guide
- Crevice-free sealing on the inside of the pipe

For this, there are connections such as those in accordance with DIN 11864, NEUMO BioConnect®, BioControl® and VARIVENT®.

The widely used connections in accordance with DIN 11851 (milk thread fitting) and per ASME BPE and DIN 32676 (clamp) were originally developed to disassemble plant components easily. They are therefore ideally suited to equipment that needs to be removed for cleaning. If measuring instruments with these process connections are operated with CIP cleaning, the appropriate profile sealing has to be used.

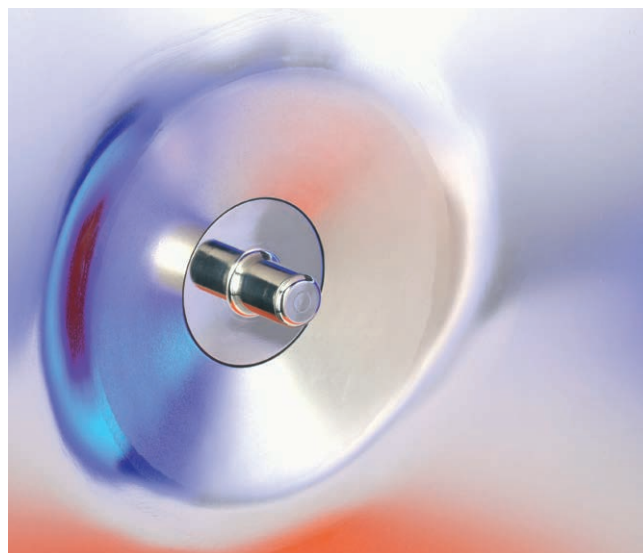

Process connections with metallic sealing components (thread with sealing cone) form a gap at the sealing point and must therefore be assessed very critically with regard to their cleanability, especially with repeated sealing and fitting following the calibration of the measuring instruments.

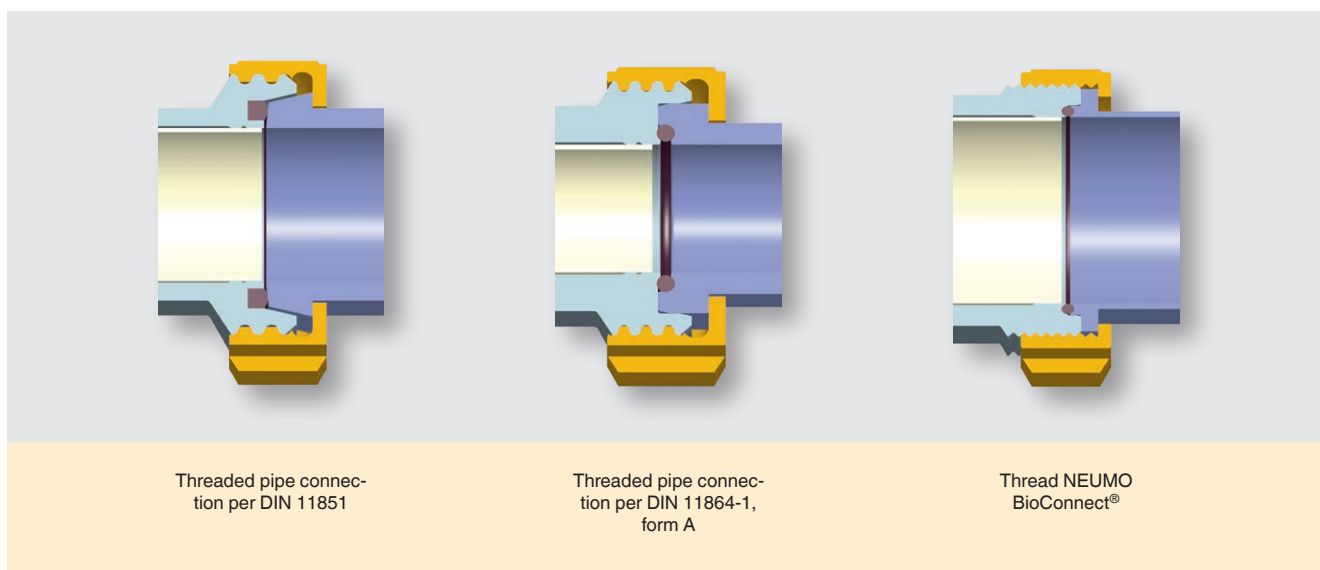

Threaded pipe connection per DIN 11851

Threaded pipe connection per DIN 11864-1, form A

Thread NEUMO BioConnect® form A

Case

The design of the non-wetted parts must be made so that the equipment is easy to clean from the outside as well. Particularly with open processes in food production, the machinery and equipment must be cleaned after production. For this, WIKA has developed specific hygienic design cases. These are easy to clean from the outside. Without any gaps or corners and with a high IP protection, these are especially suited to the harsh conditions of washdowns.

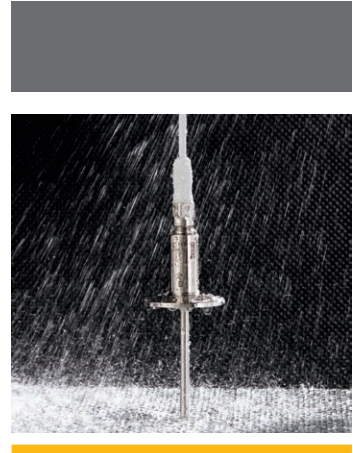

Directives and standards

WIKA combines hygienic design with high-quality measurement technology. We actively participate in international standards committees such as EHEDG, 3-A and ASME BPE. The latest market requirements flow into our product development.

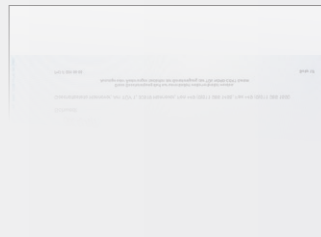
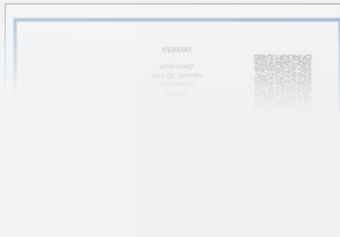
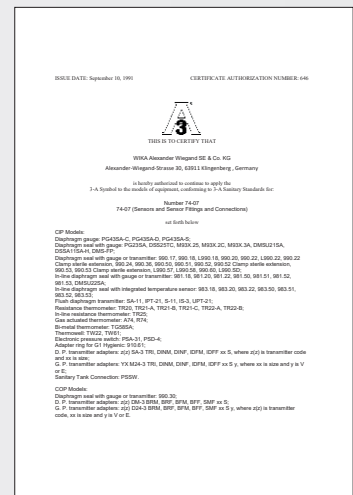
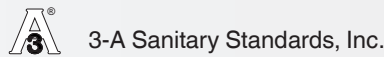
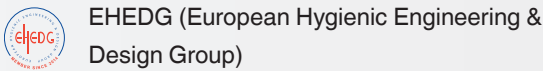
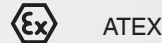
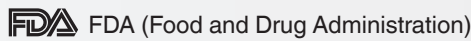

Electronic pressure measuring instruments



Electronic pressure measurement contributes to the precise and energy-saving control and regulation of processes. Alongside temperature, pressure is the most important and most common technology for monitoring and controlling plants and machinery.

With pressure measuring instruments, alongside the monitoring of process pressure and hydrostatic level measurement, a full range of process steps can be controlled, such as the dosing of inert gas blankets, the monitoring of filters in downstream areas and filling pressures. For the various applications there are a number of pressure sensors available.

The following electronic measuring instruments are particularly recommended for use in sanitary applications and for combination with diaphragm seals for a hygienic adaption to the process.

S-20

For demanding industrial applications



Non-linearity (± % of span)	≤ 0.125, 0.25 or 0.5 BFSL
Measuring range	<ul style="list-style-type: none"> ■ 0 ... 0.4 to 0 ... 1,600 bar ■ 0 ... 0.4 to 0 ... 40 bar abs. ■ -0.4 ... 0 to -1 ... +59 bar
Special feature	<ul style="list-style-type: none"> ■ Extreme operating conditions ■ Customer-specific variants ■ Free test log
Data sheet	PE 81.61

IS-3

Intrinsic safety Ex i



Non-linearity (± % of span)	≤ 0.2 BFSL
Measuring range	<ul style="list-style-type: none"> ■ 0 ... 0.1 to 0 ... 6,000 bar ■ 0 ... 0.25 to 0 ... 25 bar abs. ■ -1 ... 0 to -1 ... +24 bar
Special feature	<ul style="list-style-type: none"> ■ Further worldwide Ex approvals ■ High-pressure version (optional) ■ Flush process connection (optional)
Data sheet	PE 81.58

PSD-4

Electronic pressure switch with display



Accuracy (% of span)	≤ 0.5
Measuring range	0 ... 0.4 to 0 ... 1,000 bar 0 ... 0.4 to 0 ... 25 bar abs. -1 ... 0 to -1 ... +24 bar
Special feature	<ul style="list-style-type: none"> ■ Condition monitoring via IO-Link ■ Reduction of variants ■ Easy installation, good readability ■ Parameterisation via 3 buttons
Data sheet	PE 81.86

UPT-20

Universal process transmitter, with pressure port



Non-linearity (% of span)	≤ 0.1
Output signal	4 ... 20 mA, HART®
Measuring range	0 ... 0.4 to 0 ... 1,000 bar 0 ... 1.6 to 0 ... 40 bar abs. -0.2 ... +0.2 to -1 ... +40 bar
Special feature	<ul style="list-style-type: none"> ■ Multi-functional display ■ Simple menu navigation ■ Conductive plastic case ■ Large LC display, rotatable
Data sheet	PE 86.05

IPT-20

Industrial process transmitter



Non-linearity (% of span)	≤ 0.075 ... 0.1
Measuring range	0 ... 0.1 to 0 ... 4,000 bar -1 ... 0 to -1 ... +60 bar 0 ... 0.1 to 0 ... 60 bar abs.
Output signal	4 ... 20 mA, HART®, PROFIBUS® PA, FOUNDATION™ Fieldbus
Special feature	<ul style="list-style-type: none"> ■ Freely scalable measuring ranges (turndown to 30 : 1) ■ Case from plastic, aluminium or stainless steel
Data sheet	PE 86.06

DPT-20

Differential pressure transmitter, intrinsically safe or with flameproof enclosure



Non-linearity (% of span)	≤ 0.065 ... 0.1
Measuring range	0 ... 10 mbar to 0 ... 16 bar
Output signal	4 ... 20 mA, HART® protocol (optional), PROFIBUS® PA, FOUNDATION™ Fieldbus
Special feature	<ul style="list-style-type: none"> ■ Freely scalable measuring ranges ■ Static load 160 bar, optionally 400 bar ■ Case from plastic, aluminium or stainless steel ■ With integrated display and instrument mounting bracket for wall/pipe mounting (optional) ■ 3- or 5-way valve optional ■ SIL 2 per IEC 61508
Data sheet	PE 86.22

For a hygienic process connection, a combination with our diverse diaphragm seals is possible.

Pressure sensors

SA-11

For hygienic processes



Accuracy (± % of span)	≤ 0.2
Measuring range	-0.25 ... 0 to -1 ... +24 bar 0 ... 0.25 to 0 ... 25 bar gauge 0 ... 0.25 to 0 ... 16 bar abs.
Special feature	Flush diaphragm with a surface roughness of Ra < 0.4 µm All welded
Data sheet	PE 81.80

The flush metal measuring cell of the SA-11 is directly welded to the process connection and fulfils the high demands of sanitary applications. With the gap-free connection without additional sealing between the process connection and the measuring cell, risks of leakage are eliminated.

For dead-space free instrumentation, numerous hygienic process connections are available. This is certified per 3-A Sanitary Standards as well as EHEDG.

The SA-11 pressure transmitter is exceptionally suitable for both the cleaning processes Cleaning-in-Place (CIP) and also for Sterilisation-in-Place (SIP) with elevated temperatures.



Cable outlet IP68

Angular connector 4-pin,
EN 175301-803,
form A, IP65

Circular connector
4-pin, with screw cap
M12 x 1, IP65

Stainless steel
Field case IP67

Pressure switches

The model DSSA11SA compact diaphragm seal system is particularly well suited for hygienic process integration in sanitary applications.

In the basic version, the instrument is fitted with a pressure sensor without a display, which, depending on the application, can be used either for pressure monitoring or as an electronic PNP/NPN switch for process control. The instrument is also available with an additional IO-Link interface. It can thus be programmed flexibly and has integrated diagnostic functions that monitor the instrument status. This version, which has been enhanced with a 360° LED status display, provides visual information about the status and enables intuitive and quick error detection and correction.

DSSA11SA

Compact diaphragm seal system, hygienic design, with IO-Link and switching outputs



Accuracy (% of span)	≤ ±1 ≤ ±0.5
Measuring range	0 ... 1 to 0 ... 25 bar 0 ... 15 to 0 ... 300 psi
Switching output	1 or 2 (PNP or NPN)
Data sheet	PE 95.25

Process transmitters

Through its robust stainless steel case in hygienic design, the UPT-21 process transmitter is suitable for almost all applications.

Via the display and operating module or via the HART® interface, it is scalable from 0 ... 400 mbar up to 0 ... 600 bar with the 4 ... 20 mA output signal.

The process connections are available in all popular connection geometries.

Through the hygienic case, no unwanted germs can accumulate on the instrument's surfaces. The robust design also permits cleaning with high-pressure equipment. Particularly for the measurement in tanks, the integrated firmware offers the possibility to display the filling volume directly.

IPT-21

Process pressure transmitter in stainless steel case



Accuracy	0.075 to 0.25 %
Measuring range	0 ... 0.1 to 0 ... 600 bar -1 ... 0 to -1 ... +60 bar 0 ... 0.1 to 0 ... 60 bar abs.
Output signal	4 ... 20 mA 4 ... 20 mA, HART® PROFIBUS® PA FOUNDATION™ Fieldbus
Data sheet	PE 86.06

The IPT-21 process pressure transmitter, with its 4 ... 20 mA/HART®, PROFIBUS® PA or FOUNDATION™ Fieldbus output signal, combined with the intrinsically safe ignition protection type (in accordance with ATEX or FM), is ideally suited for application in appropriate systems. The instruments can be used for standard pressure measurement and also for hydrostatic level measurement.

Special features

- High measurement accuracy
- Best long-term stability
- Freely scalable measuring ranges (turndown to 30 : 1)
- Configuration via DTM (Device Type Manager) in accordance with the FDT (Field Device Tool) concept (e.g. PACTware) and primary standards

UPT-21

Universal process transmitter with flush process connection



Non-linearity (% of span)	≤ 0.1
Measuring range	0 ... 0.4 to 0 ... 600 bar 0 ... 1.6 to 0 ... 40 bar abs. -0.2 ... +0.2 to -1 ... +40 bar
Output signal	4 ... 20 mA, HART®
Special feature	Multi-functional display (optional) Freely scalable measuring range Simple menu navigation Conductive plastic case or stainless steel case in hygienic design Large LC display, rotatable
Data sheet	PE 86.05

DPT-EL

Electronic differential pressure system with primary and secondary sensor



Application	Level or contents measurement in closed vessels
Accuracy	from 0.075 %
Measuring range	Differential pressure 0.025 ... 10 bar Static pressure: 0 ... 10 bar
Output signal	4 ... 20 mA, HART® PROFIBUS® PA FOUNDATION™ Fieldbus
Data sheet	PE 86.23

In-line process transmitter

Optimum hygienic design

Thanks to its in-line design, the sensor is suitable for pressure measurements in pipeline systems. In pharmaceutical plants and applications in the food and beverage industry, it is ideal for small pipelines with DN < 1 or DN < 25.

Suitable for CIP and SIP

The sensor is easy to clean and suitable for CIP processes. It has been designed for process temperatures up to +150 °C and is therefore suitable for the measurement of sterile steam in SIP processes.

Design

The robust in-line design increases durability compared to conventional instruments.

Sensor

The use of a dry sensor eliminates the risk of product contamination, since no system fill fluid is required.

The sensor's self-monitoring provides direct feedback to ensure hygienic integrity.

Applications

Hygienic pressure measurement for the

- pharmaceutical industry
- aseptic food processing
- Pressure/vacuum measurement on pipelines

Suitable for highly viscous media, pastes and media containing particles, solids or fibres



Patent no.
CN113454431A
EP3938750A1
US2021404898A1
WO2020182945A1

DMSU22SA

In-line process transmitter, hygienic design

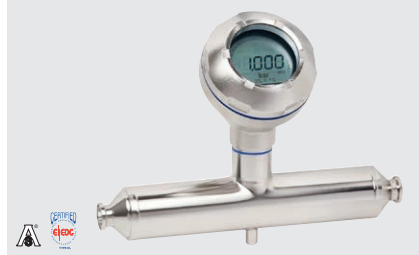

Non-linearity (% of span)	1 % (at process temperature)
Output signal	<ul style="list-style-type: none"> ■ 4 ... 20 mA with HART® signal (HART® rev. 7) ■ 4 ... 20 mA
Measuring range	<ul style="list-style-type: none"> ■ 0 ... 16 bar (0 ... 200 psi) ■ -1 ... 15 bar [-30 inHg ... +200 psi] ■ 0 ... 16 bar abs. [0 ... 200 psi abs.]
Special feature	<ul style="list-style-type: none"> ■ Dead-space free hygienic design with thick-walled sensor tube from stainless steel ■ In-line pressure measurement with sensor tube without system fill fluid ■ Continuous sensor monitoring of the double-tube system prevents contamination of process and environment
Data sheet	DS 95.03



Diaphragm monitoring

WIKA's patented double diaphragm offers a solution for critical processes where the product must not find its way into the environment, or where the fill fluid in the diaphragm seal assembly must not find its way into the product.

The system, approved as a unit with process transmitter and integrated diaphragm monitoring system, is directly integrated into the digital structures of the control system via HART® revision 7. The communications protocol transmits all measured values and the alarm signal of the safety function. This works with a double diaphragm, the evacuated space between which is monitored by a pressure switch. Should the diaphragm on the process side rupture, the switch reacts to the relieved vacuum and triggers an alarm. The second diaphragm ensures the continuous monitoring of the pressure. The user receives the damage message immediately as a status message in the HART® protocol. This enables the user to reduce the reject quantity of the process medium to a minimum.



Patent no.
US 2018180505
DE 102016015447
CN 108240885

DMS-FP

Diaphragm monitoring system



Diaphragm monitoring	Individual combination possibilities for measuring instrument and diaphragm seal
Process connection	Clamp connection per DIN 32676
Application	Sanitary applications
Material	Stainless steel 1.4435 (316L), UNS S31603
Data sheet	DS 95.20

DMSU21SA

Diaphragm monitoring system with HART® revision 7



Process connection	Clamp connection per DIN 32676, ASME BPE, Ingold, DIN 11864
Diaphragm monitoring	Integrated
Material	Stainless steel 1.4435 (316L), UNS S31603
Data sheet	DS 95.11



Pressure gauges

For a reliable on-site display of the operating pressure, a wide range of mechanical pressure measuring instruments is available. Our product line ranges from proven Bourdon tube instruments, through diaphragm element and capsule gauges to robust pressure gauges for the measurement of over-, absolute and differential pressure. The measuring instruments are characterised, in particular, by mechanics made completely from stainless steel.

Limit indicator

The limit indicator, which is available as an option, finds its application wherever overpressures must be displayed with certainty and not be tampered with.

The limit indicator is a mechanical indicator with two settings, mounted on the dial:

If the indicator is in the green field, the pressure limit being monitored has not been exceeded.

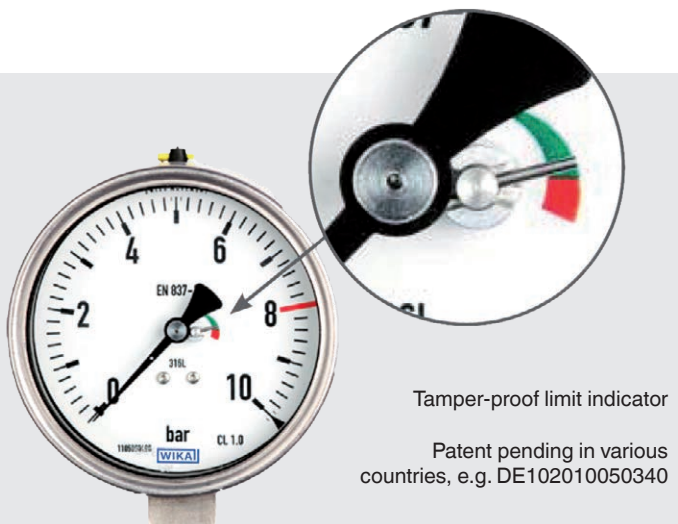

If the indicator is found in the red area, the set pressure range has been exceeded at least once. In this case, the indicator will remain permanently locked and protected from tampering in the red area.



Internal workings of a mechanical pressure measuring instrument

Pressure gauges with electrical output signal or switch contacts

Wherever the process pressure has to be indicated locally and, at the same time, a signal transmission to the central control or remote centre is desired, the model PGT23 intelliGAUGE® can be used.

Through the combination of a mechanical measuring system and electronic signal processing, the process pressure can be read securely, even if the voltage supply is lost.

Our offer is completed by the pressure gauges with switch contacts, e.g. switchGAUGE model PGS23, making it possible to simultaneously monitor the equipment and to switch circuits.

The following mechanical measuring instruments are particularly recommended for use in sanitary applications and for combination with diaphragm seals for a hygienic adaption to the process.

131.11

Stainless steel version, standard



Ex EAC

Nominal size	40, 50, 63 mm
Scale range	0 ... 1 to 0 ... 1,000 bar
Accuracy class	2.5
Ingress protection	IP54
Data sheet	PM 01.05

232.50, 233.50

Stainless steel version



Ex EAC GL

Nominal size	63, 100, 160 mm
Scale range	0 ... 0.6 to 0 ... 1,600 bar
Accuracy class	1.0/1.6 (NS 63)
Ingress protection	IP65
Data sheet	PM 02.02

232.36, 233.36

Safety version, stainless steel, high overload safety



Ex EAC S

Nominal size	100, 160 mm
Scale range	0 ... 0.6 to 0 ... 40 bar
Accuracy class	1.0/1.6 (NS 63)
Ingress protection	IP65
Data sheet	PM 02.15

PGS23

Pressure measuring instrument with switch contacts

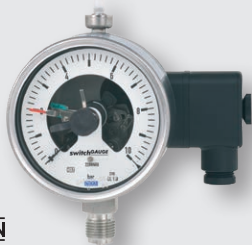

switchGAUGE
Ex EAC S DIN

Nominal size	100, 160 mm
Scale range	0 ... 0.6 to 0 ... 1,600 bar
Accuracy class	1.0
Ingress protection	IP65
Data sheet	PV 22.02

PGT23

Pressure measuring instrument with electrical output signal



intelliGAUGE
Ex EAC

Nominal size	100, 160 mm
Scale range	0 ... 0.6 to 0 ... 1,600 bar
Accuracy class	1.0
Ingress protection	IP54, filled IP65
Data sheet	PV 12.04

910.33

Adhesive label set for red and green circular arcs



intelliGAUGE
Ex EAC

Nominal size	63, 100, 160 mm
Application	Individual red-green marking of scale ranges on dial measuring instruments
Special features	Long-term stability, temperature and UV resistance
Data sheet	AC 08.03

Diaphragm pressure gauges

No risk of contamination by system fill fluid

The diaphragm measuring instruments operate without any system fill fluid. These transmit the pressure from the process to the easily readable pressure indication purely mechanically. By eliminating any liquids, the “dry measuring cell” increases the process safety for sterile pressure measurement.

Robust diaphragm element with high overload safety

Proven over decades, diaphragm elements can also withstand pressure spikes and overloads thanks to their strong diaphragms. Through this, the danger of damage to the flush diaphragm is clearly reduced.

Hygienic design

The measuring instruments have been developed for the pressure display during the processing and transport of high-value and critical media. This means that they can be cleaned easily and quickly during batch changes and are ideally suited for CIP, SIP and washdown processes.



Autoclavability

The instruments can be completely autoclaved. This means that they can be steam-sterilised together with the sterile container in an autoclave.

Thus, the measuring instruments can be installed just before the sterilization in order to save time and effort in preparation.

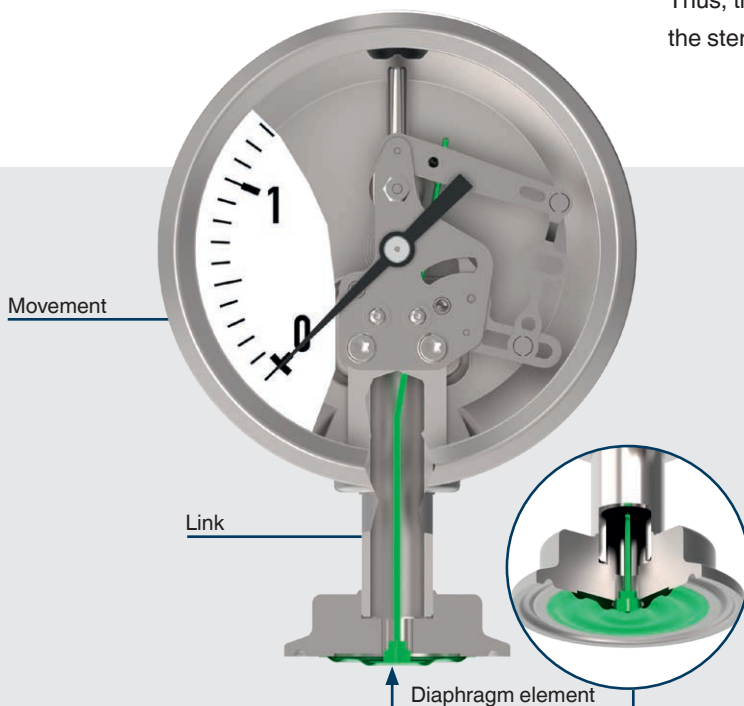

The video for this instrument family can be found here:



PG43SA-S

Pressure measuring instrument with flush diaphragm element



Nominal size	100 mm
Scale range	-1 ... 0.6 to -1 ... 15 bar 0 ... 1.6 to 0 ... 16 bar
Accuracy class	1.6
Overload safety	2 ... 5 x full scale value, max. pressure rating of the process connection
Special feature	Completely autoclavable (optional)
Data sheet	PM 04.16

PG43SA-C

Compact pressure measuring instrument with flush diaphragm element



Nominal size	63 mm
Scale range	-1 ... 2 to -1 ... 9 bar 0 ... 3 to 0 ... 10 bar
Accuracy class	2.5
Overload safety	5 x full scale value, max. pressure rating of the process connection
Special feature	Back mount version
Data sheet	PM 04.15

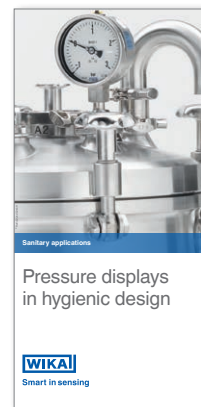

Pressure displays in hygienic design

WIKAL
Smart in sensing

Flyer
"PG43SA family"



For the highest safety aspects

PG43SA-D

Pressure measuring instrument with integrated diaphragm element monitoring



Application	For the production of active pharmaceutical ingredients (API)
Nominal size	100 mm
Scale range	-1 ... 1.5 to -1 ... 15 bar 0 ... 2.5 to 0 ... 16 bar
Accuracy class	1.6
Overload safety	1.5 ... 4 x full scale value, max. pressure rating of the process connection
Special feature	Fully autoclavable Optional sterilisation of the reference chamber per ISO 20857/2010
Data sheet	PM 04.17

Diaphragm element monitoring

The model PG43SA-D is fitted with a patented system for diaphragm element monitoring. The risk of an undetected diaphragm element rupture is eliminated.

In the event that the diaphragm element is damaged, either through improper handling or through extreme process conditions, this can lead to a crack. This is immediately indicated on the dial by a red warning point. If this point on the dial remains white, then the pressure element is intact and cost-intensive maintenance is not required.

Second barrier

For double safety, the measuring instrument has an integrated secondary barrier which, in the event of a diaphragm element break maintains the hermetic sealing of the process.

This prevents the escape of hazardous substances from the process to the environment and vice versa - excluding contamination of the process media with particles from the environment. This increases the operational and process safety in a pharmaceutical plant. Optionally, this space between the diaphragm element and the secondary barrier can be sterilised with dry heat.

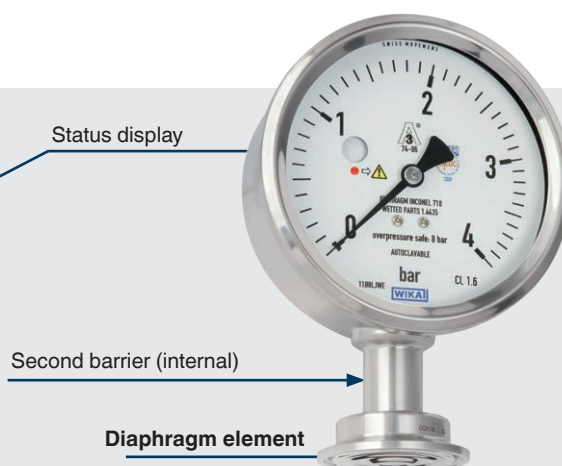
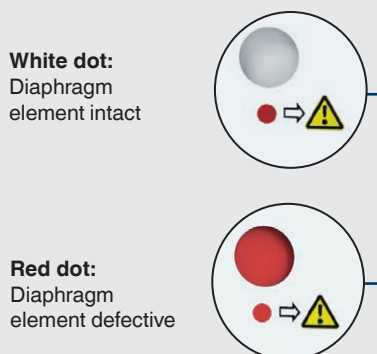

Patent pending in various countries, e.g. DE102016005568, US2016349128A1, CN106197792, DE102015006524

Connection to the process with diaphragm seals

The connection of pressure measuring instruments to the process is ideally performed by means of diaphragm seals with hygienic connections.

Diaphragm seals

Diaphragm seals separate the pressure measuring instrument, pressure sensor or pressure switch from the medium and ensure a process connection which is either free of dead spaces or where dead spaces are reduced to a minimum. The isolation is achieved by means of a flexible metal diaphragm. The internal space between the diaphragm and the pressure measuring instrument is completely filled with a fluid. The process pressure is transmitted by the elastic diaphragm into the fluid and from there to the measuring instrument.

Advantages of diaphragm seals

In contrast to ceramic principles, with diaphragm seals - as a result of the measuring cell's metallic construction - additional sealing elements are eliminated, and so the maintenance effort is significantly reduced. Ceramic measuring cells exhibit a high sensitivity to dynamic loads. With any sudden pressure spikes, the ceramic cell can be destroyed. In these cases, combinations of measuring instruments and diaphragm seals are clearly preferable.



Possibilities for combination and assembly

The combination of mechanical or electronic pressure measuring instruments with flush diaphragm seals meets the stringent demands made on hygienic instrumentation and is suitable for even the most difficult measuring requirements. Mounting of the diaphragm seals to the measuring instruments may be made via a direct connection, for high temperatures via a cooling element or via a flexible capillary.



System fill fluids for diaphragm seal systems

The media used by us are FDA-compliant.

Name	Code no.	Permissible medium temperature		Density at temperature		Viscosity at temperature		Conformities
		P ≥ 1,000 mbar abs.	P < 1,000 mbar abs.	[g/cm ³]	[°C]	[m ² /s • 10 ⁻⁶]	[°C]	
Glycerine	7	+17 ... +230 °C	–	1.26	+20	1110	+20	FDA 21 CFR 182.1320
Neobee® M-20	59	-20 ... +200 °C	-20 ... +160 °C	0.92	+20	10.1	+25	FDA 21 CFR 172.856, 21 CFR 174.5
Medicinal white mineral oil	92	-10 ... +260 °C	-10 ... +160 °C	0.85	+20	23	+40	FDA 21 CFR 172.878, 21 CFR 178.3620(a); USP, EP, JP

Neobee® is a registered trademark of the Stepan Company.
Further system fill fluids can be used for special applications after technical application support.

Diaphragm seals

Diaphragm seals are mounted to existing fittings. Usually the fittings consist of T-pieces which are integrated into a pipeline, or of welding sockets which are welded to a pipeline, the process reactor or a tank.

Diaphragm seals offer the advantage that the “contact surface” between pressure medium and diaphragm is relatively large, thus ensuring accurate pressure measurement. Furthermore, they can be easily removed for cleaning or calibration.

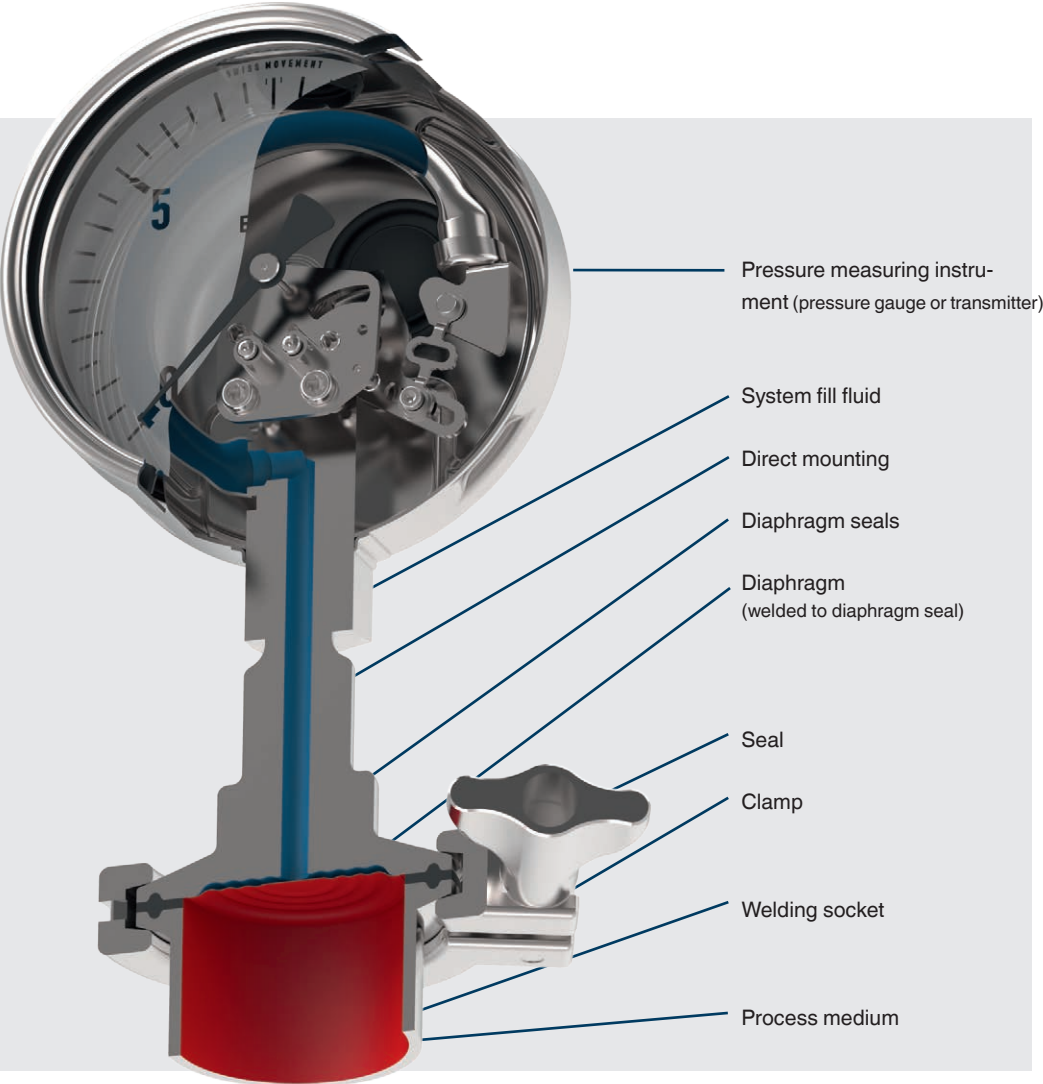

990.17

DRD connection



Process connection	DRD connection
PN max.	25 bar
Data sheet	DS 99.39



990.18

Milk thread fitting per DIN 11851



Process connection	Thread with grooved union nut
PN max.	40 or 25 bar
Data sheet	DS 99.40

990.22

TRI-CLAMP®



Process connection	TRI-CLAMP®, DIN 32676 or BS4825
PN max.	40 bar (DN 20 ... 50) 25 bar (from DN 65)
Data sheet	DS 99.41

990.24

VARIVENT® connection



Process connection	For installation into the VARINLINE® access unit or connecting flange
PN max.	25 bar
Data sheet	DS 99.49

990.50

NEUMO BioConnect® connection



Process connection	NEUMO BioConnect® thread or flange
PN max.	16 bar (thread) 70 bar (flange) Higher pressures on request
Data sheet	DS 99.50

990.51

Aseptic connection per DIN 11864



Process connection	DIN 11864-1 threaded connection DIN 11864-2 flange DIN 11864-3 clamp connection
PN max.	16 ... 40 bar depending on the process connection
Data sheet	DS 99.51

990.60

NEUMO BioControl®



Process connection	For installation into the NEUMO BioControl® system
PN max.	16 bar (size 50 ... 80) 70 bar (size 25)
Data sheet	DS 99.55

Diaphragm seal systems

These diaphragm seal systems have been developed for hygienic applications in the pharmaceutical industry and for food and beverage production. They are suitable for quick, residue-free cleaning, in particular for cleaning in place (CIP) and sterilisation in place (SIP).

The clamp connections are fast and easy to open for cleaning or seal replacement.

M932.25

Compact pressure gauge in accordance with ASME with 3/4" clamp connection



Process connection	TRI-CLAMP® per ASME BPE 3/4", 1"
PN max.	600 psi (40 bar)
System fill fluid	KN7
Data sheet	M93x.25

DSS18F, DSS19F

With pressure gauge per EN 837-1, with milk thread fitting or SMS threaded connection



Process connection	DSS18F: Grooved union nut/ threaded coupling DSS19F: Threaded connection per SMS standard (SS 3352)
PN max.	25 bar
System fill fluid	KN92
Data sheet	DS 95.04, DS 95.21

DSS22F

With pressure gauge per EN 837-1, with clamp connection



Process connection	TRI-CLAMP®, DIN 32676 or BS4825
PN max.	25 bar
System fill fluid	KN92
Data sheet	DS 95.06

DSS22P

With pressure gauge in hygienic design, with clamp connection



Process connection	TRI-CLAMP®, DIN 32676 or BS4825
PN max.	25 bar
System fill fluid	KN92
Special feature	External zero point setting Electropolished case Autoclavable
Data sheet	DS 95.07

DSS18T

With high-quality pressure sensor, with milk thread fitting



Process connection	Milk thread fitting per DIN 11851
PN max.	25 bar
System fill fluid	KN92
Data sheet	DS 95.05

DSS19T

With high-quality pressure sensor, with SMS threaded connection



Process connection	Threaded connection per SMS standard (SS 3352)
PN max.	25 bar
System fill fluid	KN92
Data sheet	DS 95.06

DSS22T

With high-quality pressure sensor, with clamp connection



Process connection	TRI-CLAMP®, DIN 32676 or BS4825
PN max.	25 bar
System fill fluid	KN92
Data sheet	DS 95.08

In-line diaphragm seals

The in-line diaphragm seal is perfectly suited for use with flowing media. With the seal being completely integrated into the process line, measurements do not cause any disturbing turbulences, corners, dead spaces or other obstructions in the flow direction.

The measured medium flows, without obstruction, through the in-line diaphragm seal. This effects an additional self-cleaning of the measuring chamber.

The in-line diaphragm seal is installed directly into the pipeline.

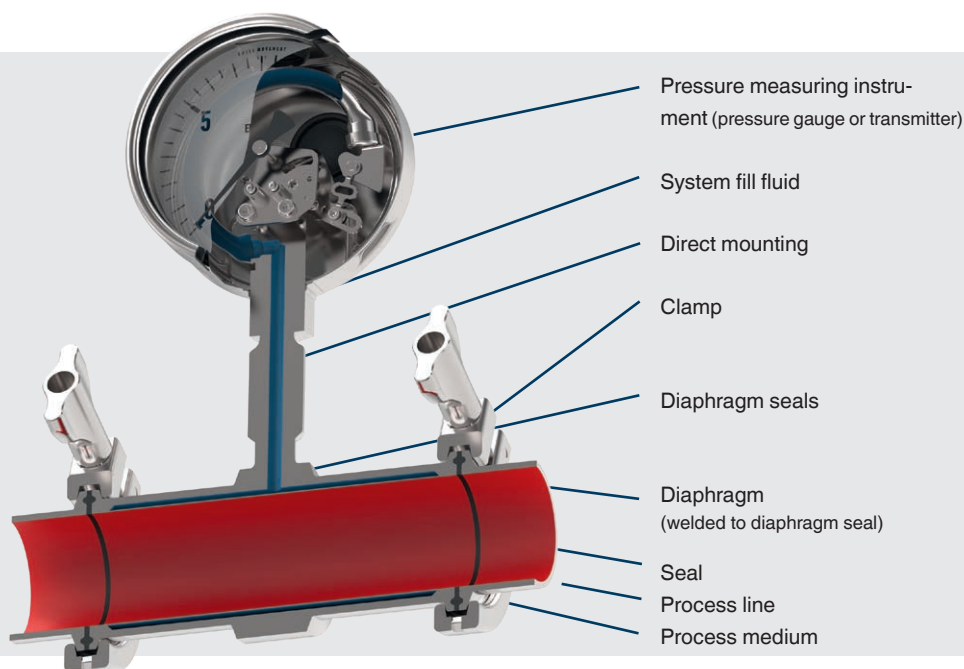

981.18

Milk thread fitting DIN 11851



Process connection	Thread
PN max.	40 bar (DN 20 ... 40) 25 bar (from DN 50)
Data sheet	DS 98.40

981.22

TRI-CLAMP®



Process connection	TRI-CLAMP®, clamp DIN 32676, ISO 2852
PN max.	40 bar (DN 20 ... 40) 25 bar (from DN 50)
Data sheet	DS 98.52

981.51

Aseptic connection



Process connection	DIN 11864-1 threaded connection DIN 11864-2 flange DIN 11864-3 clamp connection
PN max.	16 ... 40 bar depending on the process connection
Data sheet	DS 98.51

981.50

NEUMO BioConnect®



Process connection	NEUMO BioConnect® thread or flange
PN max.	16 bar (thread) 70 bar (flange) Higher pressures on request
Data sheet	DS 98.50

Precision digital pressure gauges with diaphragm seals

CPG1500

Precision digital pressure gauge



Measuring range	-1 ... 10,000 bar
Accuracy (% of span)	Down to 0.05 % FS
Special feature	Integrated data logger WIKA-Cal compatible Data transfer via Bluetooth® Password protection possible Robust case IP65
Data sheet	CT 10.51

When assembled with the model 990.22 diaphragm seal, the CPG1500 is optimally suited for processes in the food and pharmaceutical industries. The large display enables the measured values to be read easily and precisely.

The instrument can also be used for leakage monitoring on mobile aseptic or sterile vessels, in particular for vessels with low pressure blankets. With the help of the data logging function, the measured values can be recorded over a long period of time.

Pressure measuring instruments for homogenisers

Pressure measuring instruments with model 990.30 diaphragm seals have been specifically developed for homogenising processes, where there are extremely dynamic pressure loads.

Complex structural features allow pressures of up to 2,500 bar and ensure a long service life. The model is available as a purely mechanical solution or with a 4 ... 20 mA output signal.

Further information on model 990.30 can be found in data sheet DS 99.33.



Risk minimisation

Optimum cleanability

- Fully welded → No gasket, maintenance free connection
- Orbital welding → Controlled weld seams
- Principle in accordance with ASME BPE
- Measuring insert can be removed for calibration without opening the process → No breach of the sterile boundary
- Measurement in the core of the flow
 - High accuracy to protect temperature-sensitive products
 - Fast response time

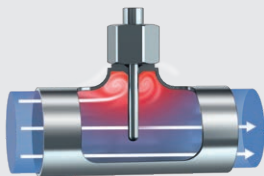

Previous protection tube

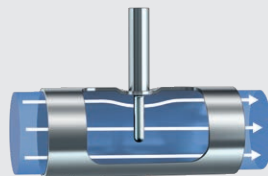

Model TW61 dead-space free protection tube – for orbital welding

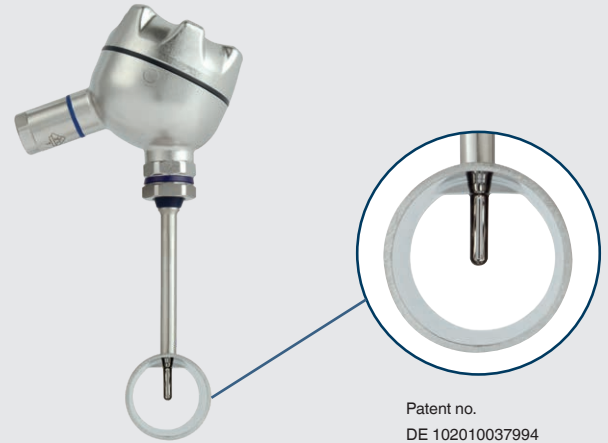

Patent no.
DE 102010037994
US 12 897.080



Patent, property right:
GM 000984349

Flush temperature instrumentation for mixing vessels

Inside the mixing vessel

External components

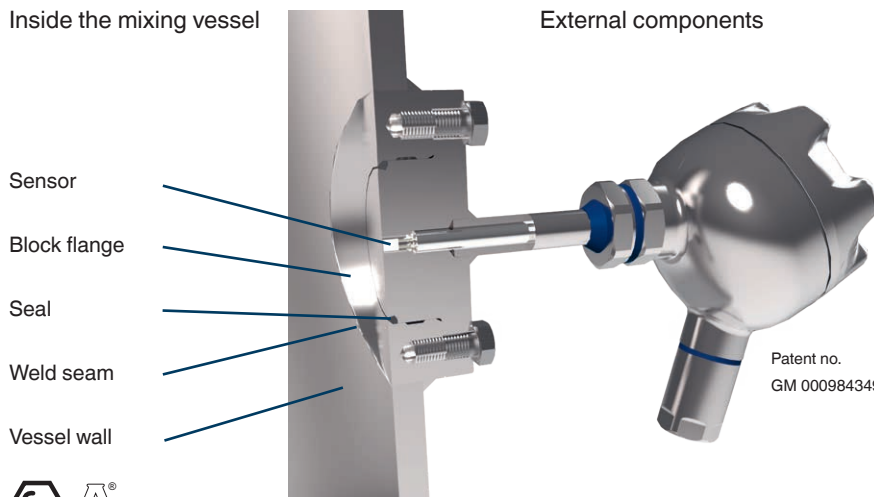

Patent no.
GM 000984349

- No intrusion into the process
- Enables easy removal of process medium from the inner wall by rotating wipers
- No risk of process contamination
- Easy to clean – reduced time for cleaning
- Higher accuracy than surface mounted sensors
- Fast response time through face-sensitive sensor installation
- TR20 in conjunction with a BioControl® block flange 910.60

Electrical temperature measurement

Resistance thermometers are equipped with metallic-conductor based sensor elements which change their electrical resistance as a function of temperature. The connection to the evaluation electronics (transmitter, controller, display, chart recorder, etc.) can be made with a 2-, 3- or 4-wire circuit, depending on the application. In the food and beverage industry, as well as in pharmaceuticals, biotechnology and cosmetics manufacturing, the focus is on more than just providing temperature readings.

The instruments for electrical temperature measurement are characterised by the following features:

Individuality

Through tailored thermometer designs corresponding to your process and the available space

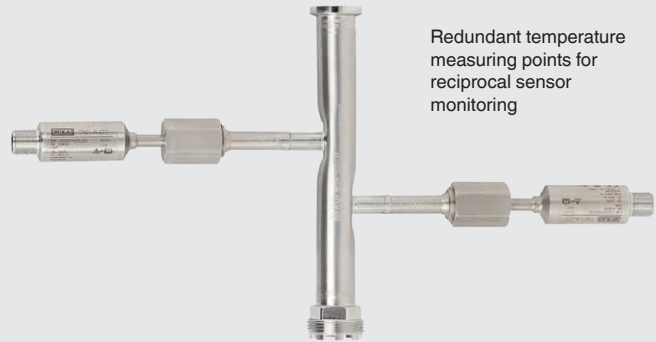
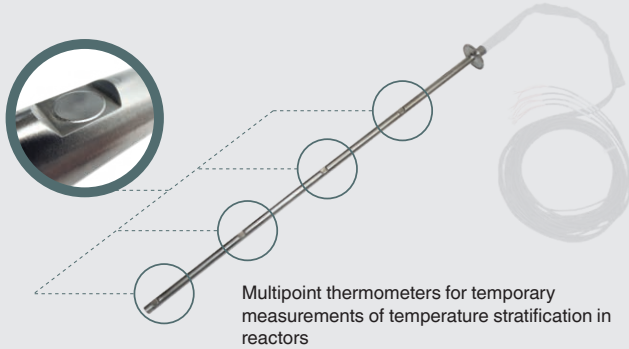

Flexibility

Through different thermowells, sensors and signal processing possibilities

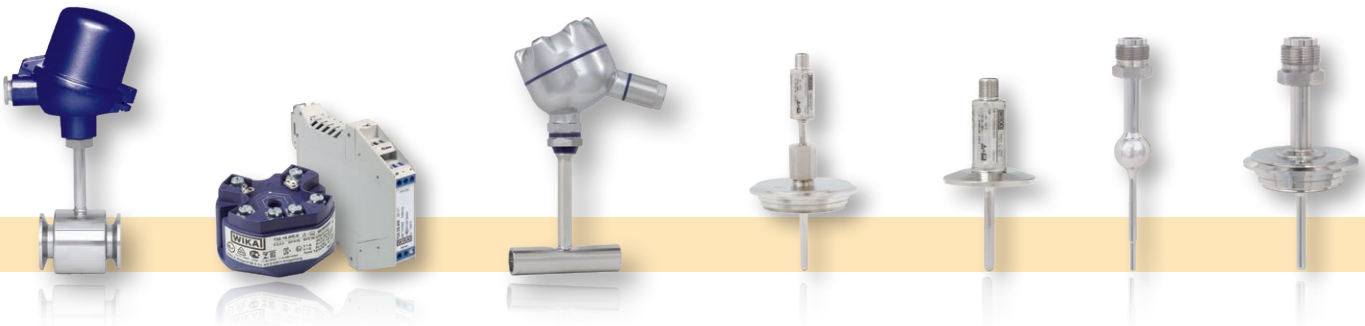

Modularity

Through detachable thermometer-thermowell connections and standardised measuring inserts for simplified storage

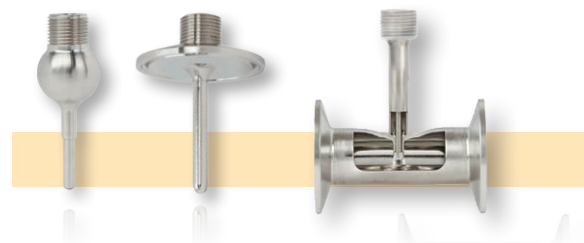

Step-response behaviour following a temperature change

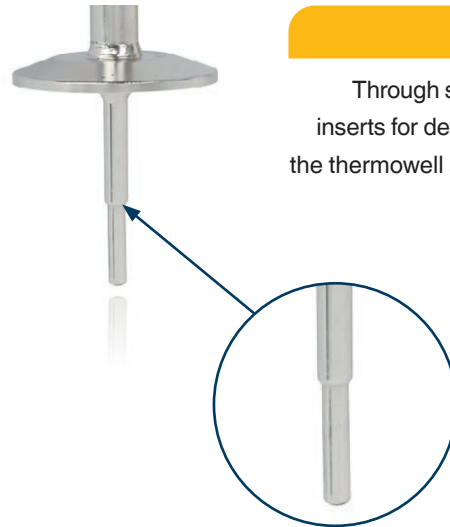
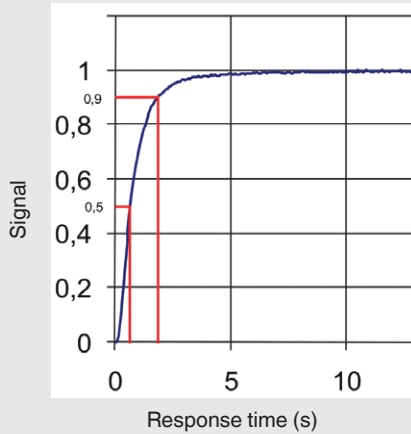

Speed

Through spring-loaded measuring inserts for defined fitting conditions in the thermowell and optimised response times



Reliability and high plant availability

Through a high IP ingress protection of up to IP69K for particularly harsh ambient conditions during a washdown. Through easy and quick cleanability with dead-space free and patented measuring instruments, 3-A marked and EHEDG-certified



Compact and safe

Through space-saving cases, for hazardous areas



Electrical temperature measuring instruments



For temperature measurement in the widest range of applications, WIKA offers a comprehensive product programme of electrical thermometers. The TR21 series is characterised by a compact design and fast electrical connection. The series cases are available with IP68 and IP69K protection. In the TR22 series WIKA's proven temperature transmitters are used, with which all standard output signals are available.

Easy calibration or maintenance, without having to open the process, is possible in both series with connection to the process via thermowell. In this way, hygiene risks can be minimised and downtimes can be reduced. Suitability for use in sanitary applications is confirmed by the successful 3-A auditing and EHEDG certification.

TR21-A

Miniature design
with flange connection



Sensor element	Pt100, Pt1000
Measuring range	-30 ... +250 °C
Output	Pt100, Pt1000, 4 ... 20 mA
Connection to thermowell	Removable G 3/8"
Ingress protection	IP69K autoclavable
Data sheet	TE 60.26

TR21-B

Miniature design for
orbital welding



Application	Invasive temperature measurement in the product stream
Sensor element	Pt100, Pt1000
Measuring range	-30 ... +150 °C
Output	Pt100, Pt1000, 4 ... 20 mA
Connection to thermowell	Removable G 3/8"
Ingress protection	IP69K autoclavable
Data sheet	TE 60.27

TR21-C

Miniature design with welded
flange connection



Sensor element	Pt100, Pt1000
Measuring range	-30 ... +250 °C
Output	Pt100, Pt1000, 4 ... 20 mA
Connection to thermowell	Welded
Ingress protection	IP69K autoclavable
Data sheet	TE 60.28

TR22-A

With flange connection



Sensor element	Pt100
Measuring range	-50 ... +250 °C
Output	Pt100, 4 ... 20 mA
Connection to thermowell	Removable M24
Data sheet	TE 60.22

TR22-B

For orbital welding



Application	Invasive temperature measurement in the product stream
Sensor element	Pt100
Measuring range	-50 ... +150 °C
Output	Pt100, 4 ... 20 mA
Connection to thermowell	Removable M24
Data sheet	TE 60.23

TR25

In-line resistance thermometer



Application	For piggable systems and powdery media
Sensor element	Pt100
Measuring range	-50 ... +150 °C
Output	Pt100, 4 ... 20 mA
Pin assignment	3- or 4-wire
Data sheet	TE 60.25

TR57-M

Pipe surface resistance thermometer for clamping



Sensor element	1 x Pt100
Measuring range	-20 ... +150 °C
Output	Pt100, 4 ... 20 mA
Data sheet	TE 60.57

TR20

Flush



Application	For flush vessel mounting when using wipers
Sensor element	Pt100
Measuring range	-50 ... +250 °C
Output	Pt100, 4 ... 20 mA
Connection method	2-, 3- and 4-wire
Accessories	BioControl® block flange 910.60, see data sheet AC 09.14
Data sheet	TE 60.20

Temperature transmitters

Transmitters convert the temperature-dependent change in resistance of resistance thermometers or the temperature-dependent voltage change in a thermocouple into a proportional standard signal. The most commonly used standard signal is the analogue 4 ... 20 mA signal, though digital signals (fieldbus) are gaining more and more importance.

By using intelligent circuit concepts with analogue 4 ... 20 mA signals, any sensor errors that occur are signalled and simultaneously transmitted with the measured value over a two-wire line (current loop). The conversion and transmission of the standard signals (analogue or digital) is made over long distances and completely fail-safe. A temperature transmitter can either be mounted directly at the measuring point in the connection head or on a DIN rail in a control cabinet.



Interoperability: Internal and external tests certify the compatibility of our transmitters with almost all open software and hardware tools.

T32

HART® transmitter



Input	Resistance thermometers, thermocouples, potentiometers
Accuracy	< 0.1 %
Output	4 ... 20 mA, HART® protocol
Special feature	TÜV-certified SIL version (full assessment)
Data sheet	TE 32.04

T15

Digital temperature transmitter for resistance sensors



Input	Resistance thermometers, potentiometers
Accuracy	< 0.1 %
Output	4 ... 20 mA
Special feature	The fastest and simplest configuration on the market
Data sheet	TE 15.01



Dial thermometers

For temperature measurement with dial thermometers, WIKA manufactures bimetal and gas-actuated thermometers.

Due to their simple design, bimetal thermometers are suitable for displaying temperature reliably, even under difficult conditions such as shocks or vibrations.

If, however, fast temperature measurement is required or if long distances have to be bridged needing no auxiliary power, gas-actuated thermometers are recommended.

TG58SA

Bimetal thermometer for sanitary applications



Nominal size	63, 80, 100, 130 mm
Scale range	-50 ... 50 °C to -20 ... 200 °C
Wetted parts	Stainless steel 316L
Option	<ul style="list-style-type: none"> ■ Case filling with FDA-approved silicone oil ■ Certification packages for food and pharmaceutical applications
Data sheet	TM 58.01

74

Gas actuated thermometer for sanitary applications



Nominal size	100 mm
Scale range	0 ... 120 or 0 ... 160 °C
Wetted parts	Stainless steel 1.4435
Option	<ul style="list-style-type: none"> ■ Liquid damping (case) ■ Wetted parts with electropolished surface
Data sheet	TM 74.01

Combination possibilities for dial thermometers with hygienic thermowells

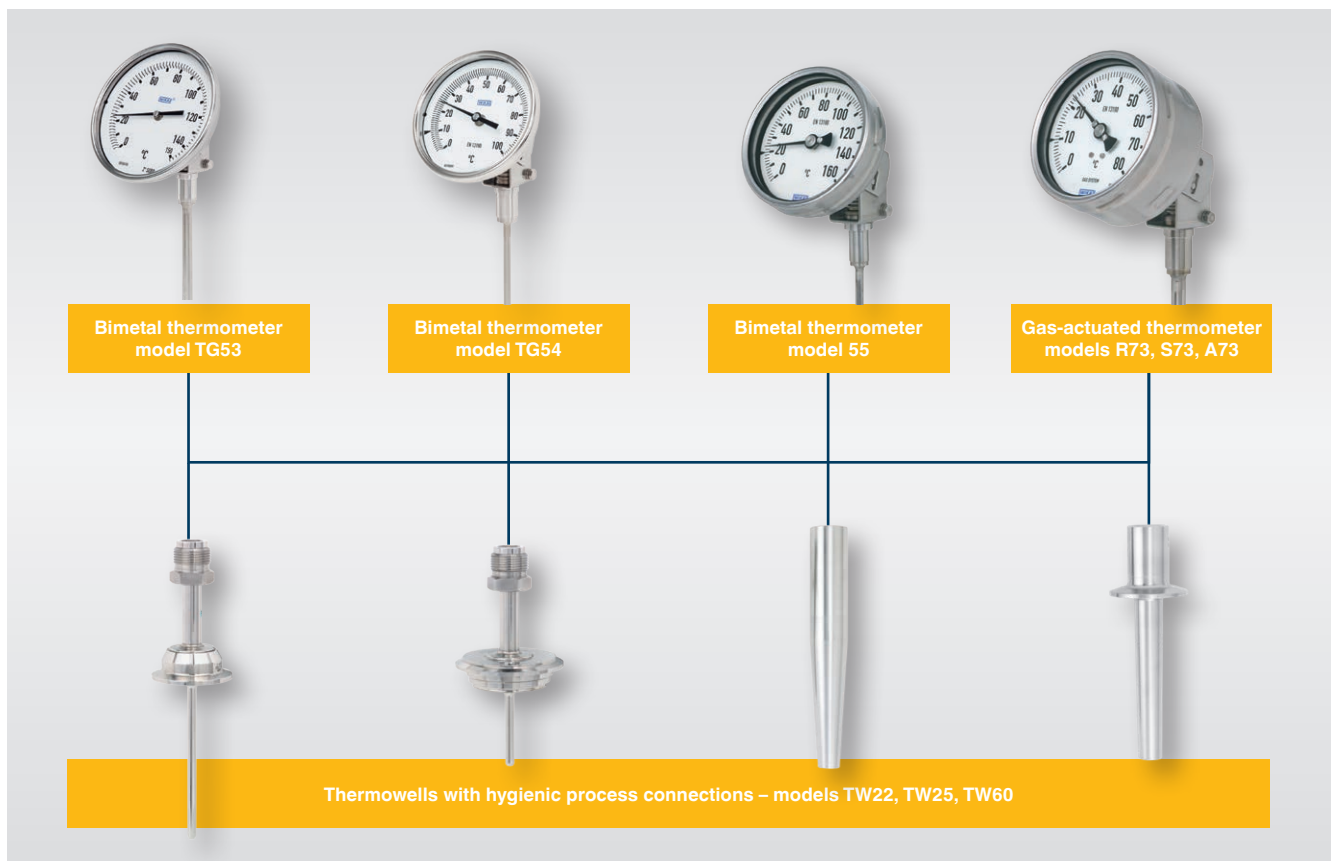

Gravimetric level measurement and weighing with force measurement

Gravimetric level monitoring refers to the control of levels through measuring the weight of vessels and the contents within them. From the measured data, the filling height is calculated. Gravimetric level measurement is in demand in temperature-critical applications and where robustness and high durability or non-invasive measurements are required. High-accuracy weight detection without any material contact is possible with this method. Therefore, it is particularly suitable for sterile tanks, buffer vessels and storage tanks.

Typical areas of application include gravimetric level monitoring of vessels and silos as well as weighing in process plants and dosing systems.

In biotechnological process engineering, the contents of a bioreactor can be measured non-invasively using weighing technology.

This method of measurement offers the following advantages:

- The operator can simultaneously determine the level and the exact mass
- No intrusion into the tank or vessel is needed
- High-accuracy weight determination without any contact with the media
- The measurement is independent of the material, its properties and the vessel geometry
- Simple replacement of the bending or shear beams
- Verifiable measurement is possible
- As suitable for small vessels as it is for large silos up to 1,200 t
- Long-term stability
- Low maintenance effort

Design of the measuring system

- 1 The load cells can be connected to a junction box by cable in the traditional way so that the totalised signal is shown on a display. From there, the fill level can be transmitted to a large display and/or an overview platform.
- 2 Alternatively, the load cells can be equipped with transmitter modules so that the measured values of each measuring instrument can be transmitted wirelessly to a cloud via a gateway. From there, the data can be retrieved, prepared and visualised.

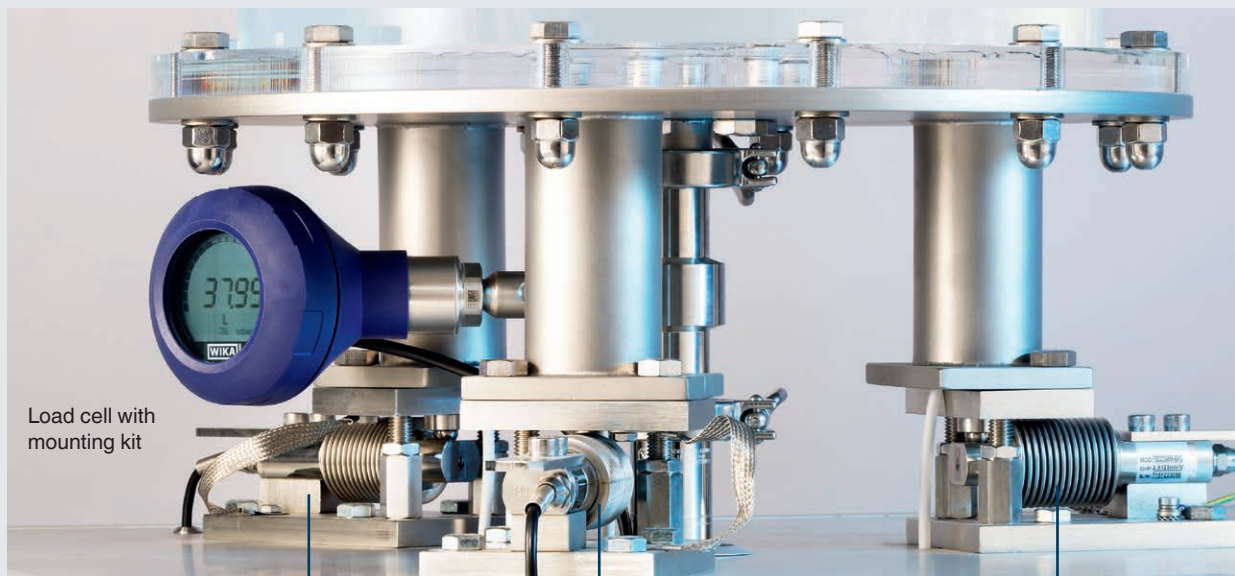

Load cell with mounting kit



Tension/compression force transducers, single point load cells

Tension/compression force transducers are used as a traditional s-type for weighing suspended loads such as big bags, for example.

Single point load cells are particularly suitable for use in platform scales. They can be mounted directly under platforms without any additional design engineering and adjustment effort.

The load cell is easy to handle due to its simple force introduction.

F2802

Tension/compression force transducer, s-type to 50 kN



ERC

Rated force F_{nom}	0 ... 0.5 kN to 0 ... 50 kN
Relative linearity error d_{lin}	■ Steel $\pm 0.03\% F_{nom}$ ■ Stainless steel $\pm 0.05\% F_{nom}$
Output signal	2.0 \pm 0.001 mV/V
Ingress protection	IP65 (< 5 kN), IP67 (\geq 5 kN)
Data sheet	FO 51.48

F2808

Tension/compression force transducer from 5 N

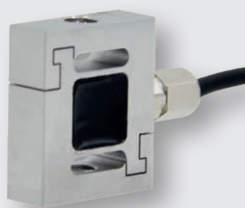

ERC

Rated force F_{nom}	0 ... 5 N to 0 ... 2,000 N
Relative linearity error	$\pm 0.15\% F_{nom}$
Output signal	2.0 \pm 0.001 mV/V
Ingress protection	IP66
Data sheet	FO 51.68

F4801

Single point load cell up to 250 kg

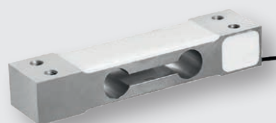

ERC

Rated load F_{nom}	0 ... 3 to 0 ... 250 kg
Relative linearity error	0.02 % F_{nom}
Output signal	2.0 \pm 0.001 mV/V
Ingress protection	IP65
Data sheet	FO 53.10

F4802

Single point load cell up to 10 kg

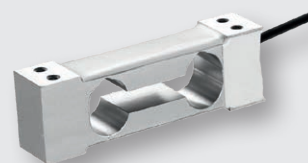

ERC

Rated load F_{nom}	0 ... 0.3 kg to 0 ... 10 kg
Relative linearity error	0.02 % F_{nom}
Output signal	■ 1.0 \pm 10 % mV/V (0.3 - 0.5 kg) ■ 2.0 \pm 10 % mV/V (1 - 10 kg)
Ingress protection	IP65
Data sheet	FO 53.13

F4818

Single point load cell up to 500 kg



ERC

Rated load F_{nom}	0 ... 20 kg to 0 ... 500 kg
Relative linearity error	0.02 % F_{nom}
Output signal	2.0 \pm 0.001 mV/V
Ingress protection	IP65
Data sheet	FO 53.14

F4881

Load cells for multihead weighers

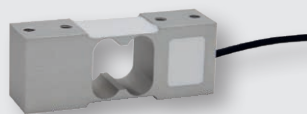

ERC

Rated load F_{nom}	0 ... 2 kg to 0 ... 30 kg
Relative linearity error	0.02 % F_{nom}
Output signal	2.0 \pm 0.2 mV/V
Ingress protection	IP67
Data sheet	FO 53.16

F4882, F4883, F4884, F4885

Load cells for checkweighers

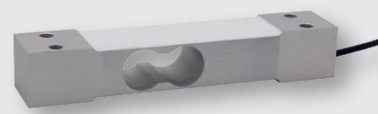

ERC

Rated load F_{nom}	0 ... 1 kg to 0 ... 635 kg
Relative linearity error	\leq 0.02 % F_{nom}
Output signal	2.0 \pm 0.2 mV/V
Ingress protection	IP66 or IP67
Data sheet	FO 53.17, FO 53.18, FO 53.19, FO 53.20

Shear and bending beams

Shear and bending beams are used in industrial weighing and laboratory technology, and also in the process industry. They allow for highly accurate weighing of, for example, tanks and vessels.

Bending beams are used in dosing units and in hopper and industrial scales. Shear beams are used for higher loads.

The associated mounting kits allow the load cell to be easily implemented under a scale or vessel. The load cell can be easily removed and installed in the final mounting kit, for example for calibration.

F3201

Shear beam up to 2,000 kg



Rated load F_{nom}	0 ... 500 to 0 ... 2,000 kg
Relative linearity error	0.017 % F_{nom}
Output signal	2.0 mV/V
Ingress protection	IP68 and IP69K
Data sheet	FO 51.72

This shear beam can be delivered with the AZK02 mounting kit.

F3203

Bending beam to 500 kg



Rated load F_{nom}	0 ... 20 to 0 ... 500 kg
Relative linearity error	0.017 % F_{nom}
Output signal	2.0 ± 1 % mV/V
Ingress protection	IP68 and IP69K
Data sheet	FO 51.73

This bending beam can be delivered with the AZK03 mounting kit.

AZK02, AZK03

Mounting kit

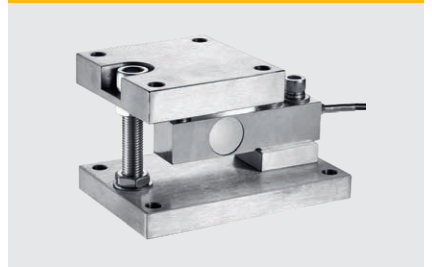

Material	Steel or stainless steel
Weight	7 kg
Data sheet	AC 50.11

Base plates, load feet and rubber elements are also available.

Accessories

Matching mounting kits, weighing modules, terminal boxes (summation units) and evaluation electronics as well as large displays are available and allow easy and safe installation in the application.

E1930, E1931

Large display or display for industrial mV/V and analogue measuring instruments



5-digit digital display with high accuracy	
Ingress protection	IP65
Data sheet	FO 58.05, FO 58.06

E1932

Multi-function display for strain gauge weighing electronics



6-digit display with approval for applications requiring verified measurements	
Ingress protection	IP65
Data sheet	FO 58.07

B6578

Junction box



4-channel	
Rugged stainless steel case	
Cable connection via clamps	
Ingress protection	IP67
Data sheet	FO 58.02

Continuous level measurement

The float-based level measurement is not influenced by moving surfaces, electric conductivity, dielectric constants, foaming and boiling surfaces.

When selecting the correct measurement principle for sanitary applications, e.g. use in fermenters and bioreactors, various criteria need to be considered with which float-based measurement technology brings advantages. Generally, in the process of fermentation, agitators and their movement cause foaming on the surface of the medium, where the foam can be fine-pored or coarse-pored, depending on the process.





Reed chain

For continuous level and interface measurement, depending on the application and measuring length, different sensor systems are available. The quasi-continuous system is based on a resistance measuring chain with reed contacts as 3-wire potentiometer circuits. With contact pitches from 5 to 20 mm – depending on the measuring length – a measurement accuracy of 1 % in 500 mm can be achieved.

FLR-H

Level transmitter, with reed measuring chain











Process connection	All common process connections in hygienic design
Guide tube length	Max. 6,000 mm
Pressure	0 ... 10 bar
Temperature	-40 ... +200 °C
Density	≥ 400 kg/m ³
Contact separation	5, 10, 15, 18 mm
Ingress protection	IP68
Data sheet	LM 20.02

FLM-H

Level transmitter, magnetostrictive, high-resolution measurement principle



Process connection	All common process connections in hygienic design
Guide tube length	Max. 6,000 mm
Pressure	0 ... 10 bar
Temperature	-40 ... +250 °C
Density	> 715 kg/m ³
Output signal	4 ... 20 mA
Accuracy	< ±0.5 mm
Resolution	< 0.1 mm
Ingress protection	IP68
Data sheet	LM 20.03

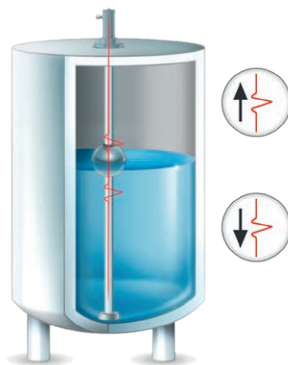

Magnetostriction

For high-accuracy measuring requirements, sensors which operate on the magnetostrictive measurement principle are available. They achieve an accuracy of 0.1 mm. These level sensors are used as measured value pick-ups for the continuous detection of liquid levels, and are based on determining the position of a magnetic float according to the magnetostrictive principle.

Level switches

For the point-based monitoring of levels, float switches are available, which are generally fitted at the top of the tank. It makes no difference whether only one or several level limits are monitored. Within the guide tube, the inert gas contacts (reed contacts) set to the predefined switching positions are activated magnetically and without contact. Depending on requirements, it is possible to define a minimum/maximum alarm value and also an emergency shutdown level. The float switches are easy to mount and maintenance-free.

FLS-H

Float switch, for vertical installation

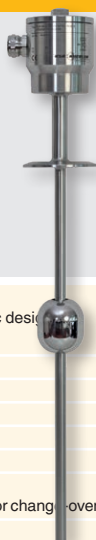



Process connection	All common process connections in hygienic design
Guide tube length	Max. 6,000 mm
Pressure	0 ... 6 bar
Temperature	-40 ... +200 °C
Density	≥ 300 kg/m ³
Pressure	0 ... 10 bar
Switching function	Alternatively normally open, normally closed or change-over
Number of contacts	Max. 6 x normally open or normally closed, or 4 x change-over
Ingress protection	IP68
Data sheet	LM 30.01



Displays/indicators and temperature controllers

The displays and indicators allow for easy reading of the measured values from electrical temperature probes, force transducers and load cells as well as pressure, temperature and level transmitters. Integrated alarm outputs enable, in addition, the control of the measured process values. Even simple two-position control, such as level control, is possible with the switching outputs from the digital indicators.

Temperature controllers are used to control the temperature in production processes or for the temperature regulation of raw materials and finished products in storage and transport vessels. With the help of switchable set points, different set points can be easily selected. Via optional serial interfaces, controllers can be connected to a network and connected to a higher-level control room.

DI10, DI25, DI30, DI32-1, DI35

For panel mounting, 48 x 24, 96 x 48, 96 x 96 mm



Input	Standard signals or multi-function input for resistance thermometers, thermocouples and standard signals
Output	2 ... 4 switch points
Auxiliary power	DC 9 ... 28 V (DI32-1, DI25) AC 100 ... 240 V (DI25, DI30, DI35) Supply from the 4 ... 20 mA current loop (DI10)
Optional special features	Integrated transmitter supply (DI25, DI30, DI35) Analogue output signal (DI25, DI35) Wall-mounting case (DI10, DI30)
Data sheet	AC 80.06, AC 80.13, AC 80.02, AC 80.05, AC 80.03

910.70

Indicator for panel mounting



Input	4 ... 20 mA, 2-wire
Output	4 ... 20 mA, 2-wire (optional)
Auxiliary power	DC 14 ... 24V
Special feature	Optical signal in the event of a sensor signal or power failure
Ingress protection	IP65/IP67 per IEC/EN 60529
Data sheet	AC 85.08

A-AI-1, A-IAI-1

LCD attachable indicators for transmitters



Dimensions	50 x 50 mm (case)
Input	4 ... 20 mA, 2-wire
Auxiliary power	Supply from the 4 ... 20 mA current loop
Special feature	Model A-IAI-1 intrinsically safe per ATEX
Data sheet	AC 80.07

CS4M

For panel mounting, 48 x 24 mm



Input	Multi-function input for resistance thermometers, thermocouples and standard signals
Control mode	PID, PI, PD, P, ON/OFF (configurable)
Monitoring output	Relay or logic level DC 0/12 V for 3-point control to control an electronic switch relay (SSR) or analogue current signal 4 ... 20 mA
Auxiliary power	AC 100 ... 240 V AC/DC 24 V
Data sheet	AC 85.06

CS6S, CS6H, CS6L

For panel mounting, 48 x 48, 48 x 96, 96 x 96 mm



Input	Multi-function input for resistance thermometers, thermocouples and standard signals
Control mode	PID, PI, PD, P, ON/OFF (configurable)
Monitoring output	Relay (AC 250 V, 3A (R) or 1A (L)) or logic level DC 0/12 V for 3-point control to control an electronic switch relay (SSR) or analogue current signal 4 ... 20 mA
Auxiliary power	AC 100 ... 240 V AC/DC 24 V
Data sheet	AC 85.08

Installation examples



Process connection of the BioControl® system

The pharmaceutical BioControl® system is used to connect pressure and temperature measuring instruments to piping systems and vessels. For the different types of problems encountered in sanitary applications, there are various designs of the BioControl® system with component approvals available.

An advantage to the user is that the system is highly flexible. In the design of the plant, it makes no difference whether the port is fitted with a pressure or a temperature measuring instrument. Design errors can be avoided due to the modular system with standardised interfaces. Furthermore, storage costs are reduced to a minimum since only a few components need to be kept in stock.

Process connection of the VARINLINE® system

To connect the pressure and temperature measuring instruments to the aseptic processes, aseptic fittings are required. For this, VARIVENT® connections are available to the process engineer in the production of food, which ensure a dead-space free transition from the process line to the measuring instrument. WIKA pressure and temperature measuring instruments with VARIVENT® connections fit smoothly into the VARINLINE® access units.

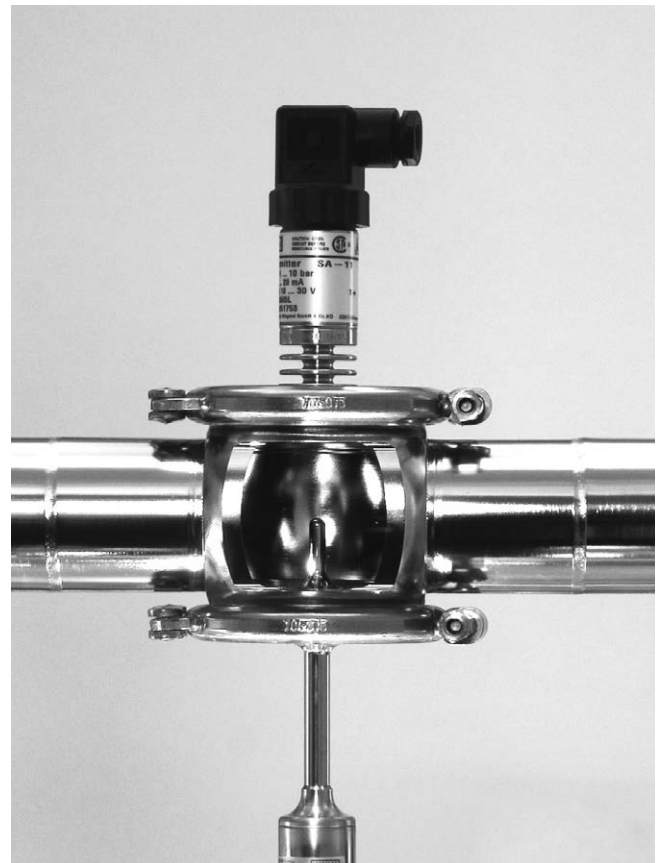

BioControl® is a registered trademark of NEUMO.
VARIVENT® and VARINLINE® are registered trademarks of the company GEA.

Model 990.22 clamp with sterile extension

WIKA has developed a diaphragm seal system with a process connection that is specifically suited to pressure measurement in sanitary applications. The EHEDG (European Hygienic Engineering & Design Group) has tested the model 990.22 clamp with sterile extension and has certified it as having exceptional suitability for sanitary applications.

The model 990.22 clamp with sterile extension is easy to handle when installing and removing. With the help of a special welding socket, a flush sealing to vessels and pipelines is ensured. Thus it offers the user an easy-to-clean pressure measuring point, which is suitable for CIP and SIP.



Weld-on adapter for flush pressure transmitters

In open vessels or vented tanks, the operator measures the level hydrostatically with a pressure transmitter. For this, one installs the measuring instrument in the bottom or close to the bottom. This measurement can be used on practically all liquids whose density remains constant. The measurement is not affected by pastes, emulsions or blends of solid ingredients. Also, hydrostatic level measurement is not affected by foaming on the liquid surface.

To mount the measuring instrument, a socket is welded into the vessel wall and the inside smoothed. This enables a flush and easy-to-clean measuring point for pressure measurement in a vessel.



Interior view of vessel

Process adapter system

The WIKA process adapter system has been developed to meet the requirements of the food, beverage and pharmaceutical industries. The adapter system consists of a pressure measuring instrument or transmitter with a built-in process adapter.

The flexible, modular system allows connection to a wide range of aseptic process connections (e.g. clamp, threaded, VARIVENT® or NEUMO®).

All parts are made of 316L/1.4435 stainless steel. The O-ring for sealing the process (optional) is supplied with a 3.1 inspection certificate per EN 10204. It is available in either EPDM or FKM and is listed as FDA, USP class VI, as well as 3-A 18-03.

The WIKA adapter system meets the high requirements of sterile processes and has been developed in accordance with the 3-A Sanitary Standards.

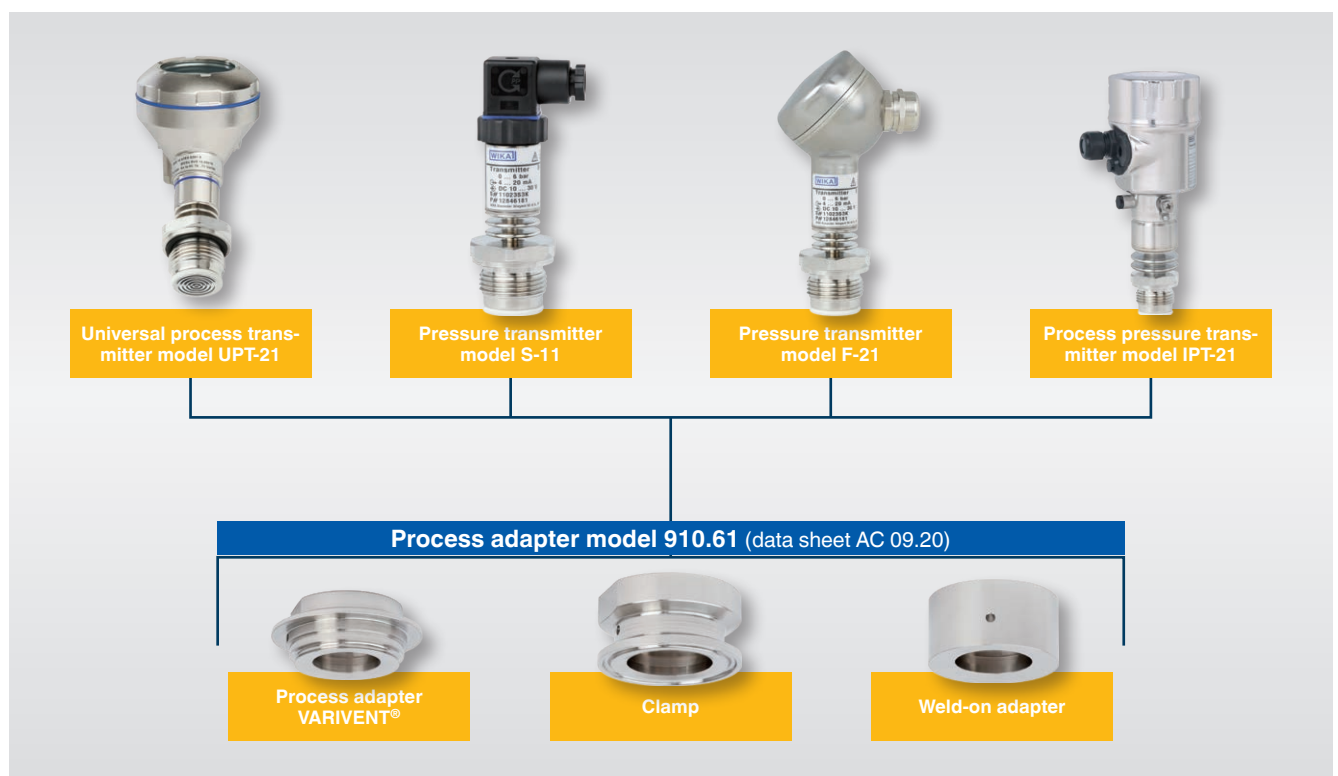

Installation examples for temperature measuring instruments

Thermowell for orbital welding

Flow-through housing

The model TW61 thermowell serves as the process connection for a model TR21-B or TR22-B resistance thermometer. The thermowell is especially suitable for the adaption of temperature measurement into pipelines for sanitary applications and for CIP and SIP processes. The ease of cleaning is ensured through the optimal hygienic design. To integrate it into the process, the thermowell is directly orbitally welded into a pipeline. The connection ends are smooth and prepared for orbital welding.

The measuring insert can be withdrawn together with the connection head. This makes it possible to calibrate the thermometer with the entire measuring chain, on-site, without disconnecting the electrical connections. In addition, this avoids having to open the process, and thus the risk of contamination is minimised.

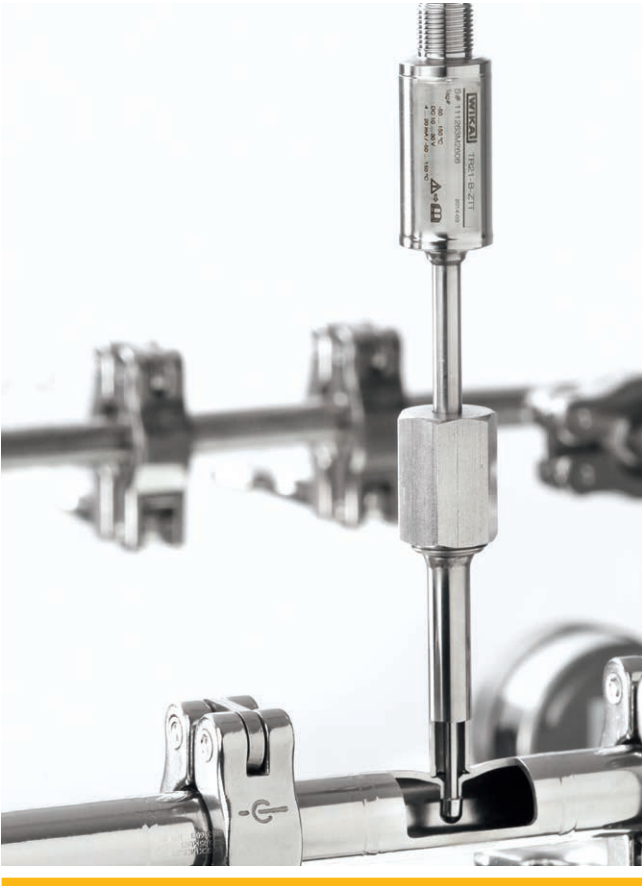

Angular housing

For small nominal pipe sizes and in cramped conditions, angular housing thermowells are available. The thermowell is dead-space optimised and is welded automatically, thus it is preferable to thermowells with welding balls and hand-welded seams. The measuring instruments should be aligned horizontally in order to avoid air pockets in the cupola.

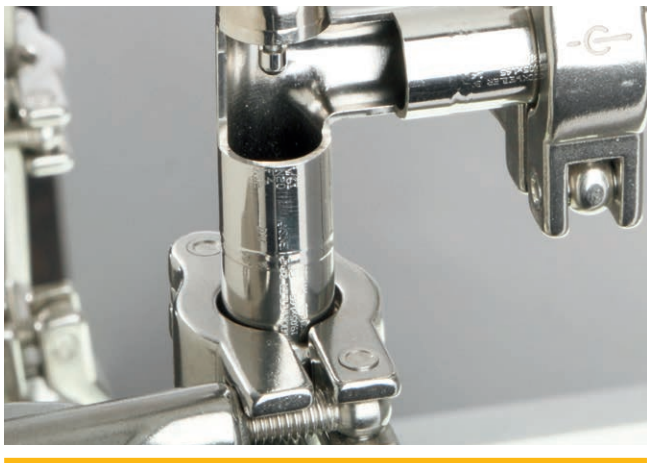

Ventilation and air-conditioning technology

With air2guide, WIKA offers a comprehensive range of measuring instruments for ventilation and air-conditioning technology.

The measuring instruments are used for differential pressure monitoring on filters, monitoring of ventilators and blowers, overpressure monitoring for clean rooms, temperature monitoring on heat exchangers, measuring of the air flow and the air velocity in air ducts and air-conditioning systems, and also for the control of air and fire shutters.



WIKA brochure "Sensing technology for ventilation and air-conditioning"



Refrigeration technology

Within the refrigeration cycle and its periphery there are many points where pressure and temperature are measured and monitored. This serves to control the plant in order to guarantee a secure process run.

In addition to the multitude of applications, the size of the refrigeration system, the refrigerant, etc. place particular demands on the measuring instruments. Here, WIKA is the competent partner for measuring instruments for pressure, temperature and calibration in all parts of refrigeration plants.



WIKA brochure "Measurement technology for refrigeration"



Lasting impressions with reliable services



Choose from our comprehensive set of services

➔ Installation & Commissioning

WIKA's field installation experts go to the customers' sites to provide tailored solutions that result in a short downtime. Process reliability is guaranteed by expert installation. Installations include multipoint thermometers in reactors, thermocouples in furnaces and level measurement instrumentation.

➔ Maintenance & Repair

You can count on WIKA to do repairs – from diaphragm seal systems up to highly accurate calibration instruments. We support you in optimising your operational processes. Benefit from our know-how for solutions that are tailored to your needs.

➔ Analysis & Support

WIKA offers reliable consultation services, both analytical and technical, for a wide range of industries. Our qualified service technicians support in solving problems and ensure that your measuring instrument is back in working order in the shortest possible time.

➔ Calibration

WIKA provides its calibration services on-site at your premises or in our laboratory, for WIKA as well as other instruments. Pressure, temperature, mass, electrical, force, dimensional, flow and torque are some of the other calibrations and adjustments that we provide on shortest delivery times.

➔ Inspection & Testing

You can rely on WIKA for on-site verification and function testing that is non-invasive and non-destructive. Our expertise also includes in-situ verifications of multipoint thermometers.



Food industry



Beverage industry



Biotechnology



Producers of active ingredients



IIoT & Digitalisation



Soaps and cosmetics



Scan for more information

For over 75 years, WIKA has helped industries all over the world meet set industry benchmarks. We took it upon ourselves and our services engagement to not just meet but also exceed those set benchmarks and expectations.

We will always want to exceed your own expectations by providing the best-in-class service. Moreover, our quality of work is backed by the strength of our OEM manufacturing expertise.

To help you do more than just the best, we also ensure global consistency, which means that you can count on us for any service engagement, be it generic or customised in nature, all over the world.

Down the street – around the world

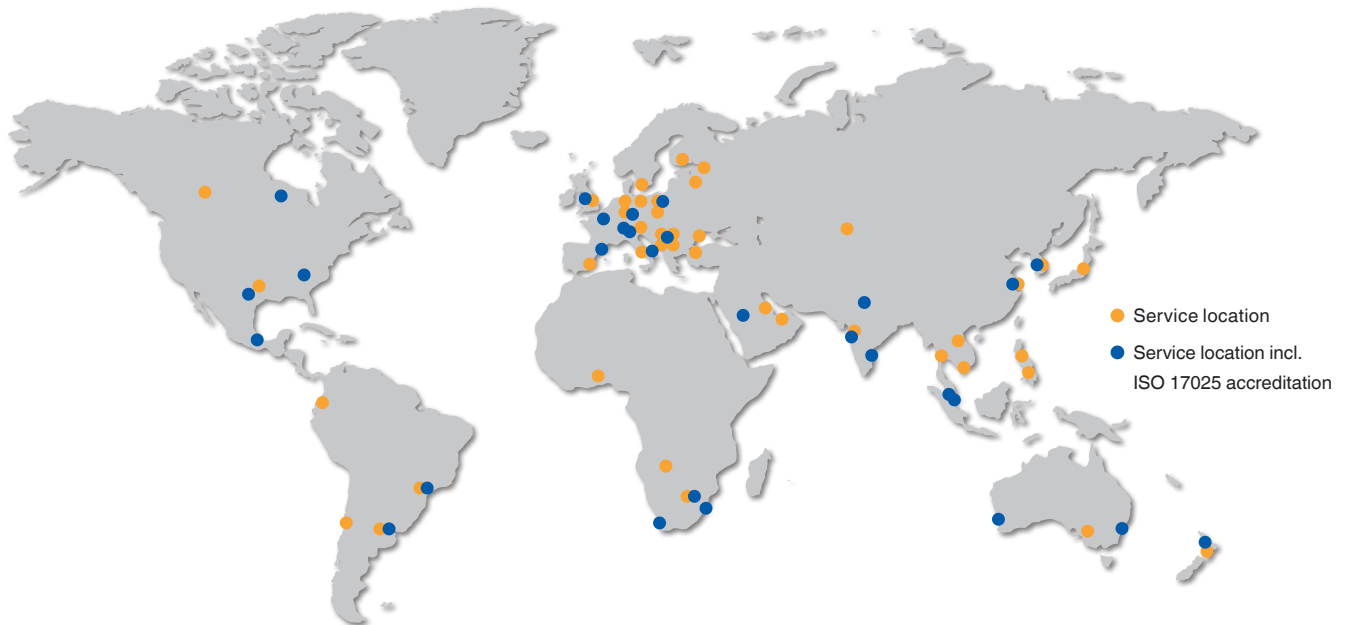

👤 Growing team with over 50 worldwide field service technicians and supervisors and already 15 mobile calibration vans deployed in various countries around the world.

📍 With our ISO 17025 accredited calibration laboratory presence in over 20 countries, we assure you that we will leave no stone unturned to ensure global consistency and standard of excellence.

★ We ensure high quality by professional training and certification of our service technicians. The observance of health and safety aspects is very important to us.

WIKA worldwide

Europe

Austria

WIKA Messgerätevertrieb
Ursula Wiegand GmbH & Co. KG
Tel. +43 1 8691631
info@wika.at / www.wika.at

Benelux

WIKA Benelux
Tel. +31 475 535500
info@wika.nl / www.wika.nl

Bulgaria

WIKA Bulgaria EOOD
Tel. +359 2 82138-10
info@wika.bg / www.wika.bg

Croatia

WIKA Croatia d.o.o.
Tel. +385 1 6531-034
info@wika.hr / www.wika.hr

Denmark

WIKA Danmark A/S
Tel. +45 4581 9600
info@wika.as / www.wika.as

Finland

WIKA Finland Oy
Tel. +358 9 682492-0
info@wika.fi / www.wika.fi

France

WIKA Instruments s.a.r.l.
Tel. +33 1 71 68 10 00
info@wika.fr / www.wika.fr

Germany

WIKA Alexander Wiegand SE & Co. KG
Tel. +49 9372 132-0
info@wika.de / www.wika.de

Ireland

WIKA Instruments Ireland Limited
Tel. +35 386 1449 360
info@wika.ie / www.wika.co.uk

Italy

WIKA Italia S.r.l. & C. S.a.s.
Tel. +39 02 93861-1
info@wika.it / www.wika.it

Poland

WIKA Polska spółka z ograniczoną
odpowiedzialnością sp. k.
Tel. +48 54 2301 10-0
info@wikapolska.pl
www.wikapolska.pl

Romania

WIKA Instruments Romania S.R.L.
Tel. +40 21 4048327
info@wika.ro / www.wika.ro

Russia

AO "WIKI MERA"
Tel. +7 495-648018-0
info@wika.ru / www.wika.ru

Serbia

WIKI Merna Tehnika d.o.o.
Tel. +381 11 2763722
info@wika.rs / www.wika.rs

Spain

Instrumentos WIKI S.A.U.
Tel. +34 933 9386-30
info@wika.es / www.wika.es

Switzerland

WIKI Schweiz AG
Tel. +41 41 91972-72
info@wika.ch / www.wika.ch

Türkiye

WIKI Instruments
Endüstriyel Ölçüm Cihazları Tic. Ltd. Şti.
Tel. +90 216 41590-66
info@wika.com.tr
www.wika.com.tr

Ukraine

TOV WIKI Prylad
Tel. +38 044 496 83 80
info@wika.ua / www.wika.ua

United Kingdom

WIKI Instruments Ltd
Tel. +44 1737 644-008
info@wika.co.uk / www.wika.co.uk

North America

Canada

WIKI Instruments Ltd.
Tel. +1 780 4637035
info@wika.ca / www.wika.ca

USA

WIKI Instrument, LP
Tel. +1 770 5138200
info@wika.com / www.wika.us

Gayesco-WIKA USA, LP

Tel. +1 713 4750022
info@wikhouston.com
www.wika.us

Mensor Corporation

Tel. +1 512 3964200
sales@mensor.com
www.mensor.com

Latin America

Argentina

WIKI Argentina S.A.
Tel. +54 11 5442 0000
ventas@wika.com.ar
www.wika.com.ar

Brazil

WIKI do Brasil Ind. e Com. Ltda.
Tel. +55 15 3459-9700
vendas@wika.com.br
www.wika.com.br

Chile

WIKI Chile S.p.A.
Tel. +56 9 4279 0308
info@wika.cl / www.wika.cl

Colombia

Instrumentos WIKI Colombia S.A.S.
Tel. +57 601 7021347
info@wika.co / www.wika.co

Mexico

Instrumentos WIKI Mexico S.A. de C.V.
Tel. +52 55 50205300
ventas@wika.com / www.wika.mx

Asia

China

WIKI Instrumentation Suzhou Co., Ltd.
Tel. +86 512 6878 8000
info@wika.cn / www.wika.com.cn

India

WIKI Instruments India Pvt. Ltd.
Tel. +1800-123-101010
info@wika.co.in / www.wika.co.in

Japan

WIKI Japan K. K.
Tel. +81 3 5439-6673
info@wika.co.jp / www.wika.co.jp

Kazakhstan

TOO WIKI Kazakhstan
Tel. +7 727 225 9444
info@wika.kz / www.wika.kz

Korea

WIKI Korea Ltd.
Tel. +82 2 869-0505
info@wika.co.kr / www.wika.co.kr

Malaysia

WIKI Instrumentation (M) Sdn. Bhd.
Tel. +60 3 5590 6666
info@wika.my / www.wika.my

Philippines

WIKI Instruments Philippines Inc.
Tel. +63 2 234-1270
info@wika.ph / www.wika.ph

Singapore

WIKI Instrumentation Pte. Ltd.
Tel. +65 6844 5506
info@wika.sg / www.wika.sg

Taiwan

WIKI Instrumentation Taiwan Ltd.
Tel. +886 3 420 6052
info@wika.tw / www.wika.tw

Thailand

WIKI Instrumentation Corporation
(Thailand) Co., Ltd.
Tel. +66 2 326 6876
info@wika.co.th / www.wika.co.th

Uzbekistan

WIKI Instrumentation FE LLC
Tel. +998 71 205 84 30
info@wika.uz / www.wika.uz

Africa/Middle East

Botswana

WIKI Instruments Botswana (Pty.) Ltd.
Tel. +267 3110013
info@wika.co.bw / wika.co.bw

Egypt

WIKI Near East Ltd.
Tel. +20 2 240 13130
info@wika.com.eg / www.wika.com.eg

Namibia

WIKI Instruments Namibia Pty Ltd.
Tel. +26 4 61238811
info@wika.com.na / www.wika.com.na

Nigeria

WIKI WEST AFRICA LIMITED
Tel. +234 17130019
info@wika.com.ng / www.wika.ng

Saudi Arabia

WIKI Saudi Arabia LLC
Tel. +966 53 555 0874
info@wika.sa / www.wika.sa

South Africa

WIKI Instruments Pty. Ltd.
Tel. +27 11 62100-00
sales@wika.co.za / www.wika.co.za

United Arab Emirates

WIKI Middle East FZE
Tel. +971 4 883-9090
info@wika.ae / www.wika.ae

Australia

Australia

WIKI Australia Pty. Ltd.
Tel. +61 2 88455222
sales@wika.com.au / www.wika.com.au

New Zealand

WIKI Instruments Limited
Tel. +64 9 8479020
info@wika.co.nz / www.wika.co.nz

Image sources:
© adobestock.com
© IStockphotos.com

WIKI Alexander Wiegand SE & Co. KG
Alexander-Wiegand-Straße 30 | 63911 Klingenberg | Germany
Tel. +49 9372 132-0 | info@wika.de | www.wika.de

9076026 01/2024 EN



You can find further
information here!



Smart in sensing

www.wika.com