

# OEM pressure switch with display

## Model PSD-4-ECO

WIKA data sheet PE 81.69



### Applications

- Machine tools
- Hydraulics and pneumatics
- Automation engineering
- Special-purpose machine building

### Special features

- Good/bad indication through parameterisable digital display (red/green)
- Compact size enables easy installation in narrow spaces
- Optimised design makes OEM machine integration easier
- Designed for rough demands of up to 50 g shock and -40 ... +125 °C [-40 ... +257 °F]



OEM pressure switch with display, model PSD-4-ECO

### Description

The model PSD-4-ECO is a programmable electronic pressure switch designed specifically for OEM customers. With IO-Link 1.1, the cost-effective and reliable model PSD-4-ECO is a future-proof automation solution. Through individual factory pre-configuration, the pressure switch can also be quickly and simply integrated into the machine without any programming effort.

#### Fast error detection through colour feedback

With the model PSD-4-ECO pressure switch, it is very easy to determine if the system is operating within the desired pressure range. The instrument can be parameterised such that the digital display lights up green when the value is within the defined pressure range and red if not. In this way, problems can be identified early.

#### Optimised for tight mounting spaces

With a diameter of 29 mm, the model PSD-4-ECO is very slim. Through the arrangement of the electrical output, it can be installed so that it uses little space. The display head can

be rotated through 335° and the display tilted electronically through 180°, so that the pressure display is always aligned towards the user.

#### Optimised for OEM integration

The pressure switch is specially adapted to the requirements of OEM series production. For example, units of 25 pieces reduce the packaging material and make handling easier. Customer-specific pre-configuration by WIKA or automated parameterisation via IO-Link 1.1 saves time and simplifies the integration process.

#### Designed for harsh ambient conditions

Tough: The model PSD-4-ECO pressure switch is designed for medium temperatures from -40 ... +125 °C. In addition, it withstands mechanical shocks up to 50 g and high electrical loads. This makes it a highly economical and reliable solution.

## Measuring ranges

Gauge pressure								
bar	0 ... 0.4	0 ... 0.6	0 ... 1	0 ... 1.6	0 ... 2.5	0 ... 4	0 ... 6	0 ... 10
	0 ... 16	0 ... 25	0 ... 40	0 ... 60	0 ... 100	0 ... 160	0 ... 250	0 ... 400
	0 ... 600	0 ... 1,000						
psi	0 ... 10	0 ... 15	0 ... 25	0 ... 30	0 ... 50	0 ... 100	0 ... 160	0 ... 200
	0 ... 300	0 ... 500	0 ... 1,000	0 ... 1,500	0 ... 2,000	0 ... 3,000	0 ... 5,000	0 ... 7,500

Absolute pressure								
bar	0 ... 0.4	0 ... 0.6	0 ... 1	0 ... 1.6	0 ... 2.5	0 ... 4	0 ... 6	0 ... 10
	0 ... 16	0 ... 25						
psi	0 ... 10	0 ... 15	0 ... 25	0 ... 30	0 ... 50	0 ... 100	0 ... 160	0 ... 200
	0 ... 300							

Vacuum and +/- measuring range								
bar	-1 ... 0	-1 ... +0.6	-1 ... +1.5	-1 ... +3	-1 ... +5	-1 ... +9	-1 ... +15	-1 ... +24
psi	-14.5 ... 0	-14.5 ... +15	-14.5 ... +30	-14.5 ... +50	-14.5 ... +100	-14.5 ... +160	-14.5 ... +200	-14.5 ... +300

The stated measuring ranges are also available in kg/cm<sup>2</sup> and MPa.

Special measuring ranges between 0 ... 0.4 and 0 ... 1,000 bar (0 ... 10 bis 0 ... 7,500 psi) are available on request.

Special measuring ranges have a reduced long-term stability and higher temperature errors.

### Overload safety

The overload safety is based on the sensor element used. Depending on the selected process connection and sealing, restrictions in overload safety can result.

≤ 600 bar [≤ 8,000 psi]: 2 times

> 600 bar [> 8,000 psi]: 1.5 times

### Increased overload safety (option)

Deviating temperature errors and long-term stability with respect to the selected measuring range apply here.

### Vacuum-tight

Yes

## Digital display

7-segment LED, 2-coloured red/green, 4-digit, 8.9 mm [0.35 in] character size

Display can be rotated electronically through 180°

Colour ranges through green/red switching can be parameterised

Display can be rotated mechanically through 335°

## Output signals

Switching output		Analogue signal
SP1	SP2	
PNP	PNP	-
PNP	-	4 ... 20 mA (3-wire)
PNP	-	DC 0 ... 10 V (3-wire)
PNP	PNP	4 ... 20 mA (3-wire)
PNP	PNP	DC 0 ... 10 V (3-wire)

Optionally also available with an NPN instead of a PNP switching output

### IO-Link (option)

IO-Link is available for all output signals with PNP output.

Revision: 1.1  
 Speed: 38.4 kBaud (COM2)  
 Min. cycle time: 2.3 ms  
 Master port class: A

### Adjustment of zero point offset

max. 3 % of span

### Damping of analogue output/switching outputs

0 ms ... 65 s (adjustable)

### Switch-on time

1 s

### Switching thresholds

Switch point 1 and switch point 2 are individually adjustable

### Switching functions

Normally open, normally closed, window, hysteresis (adjustable)

### Switching voltage

Power supply - 1 V

### Switching current

max. 250 mA to 85 °C [176 °F]

max. 250 mA to 70 °C [176 °F] with UL approval

For details, see the derating curves below

### Settling time/response time

Output signal: ≤ 5 ms

Switching output: ≤ 5 ms

### Load

4 ... 20 mA: ≤ 500 kΩ

DC 0 ... 10 V: > max. output voltage / 1 mA

### Service life

100 million switching cycles

Derating curve per switching output (without UL approval)

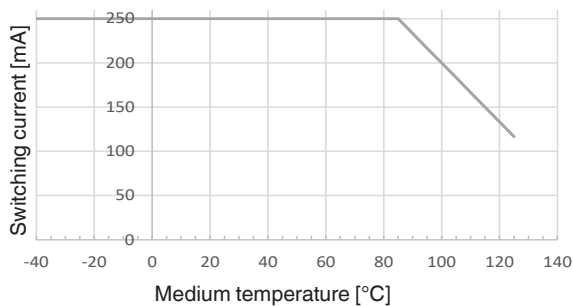

Derating curve per switching output (with UL approval)

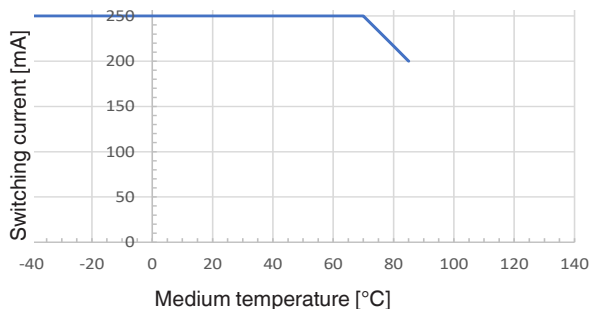

## Voltage supply

### Power supply

DC 15 ... 32 V

### Current consumption

≤ 45 mA for versions without analogue signal  
≤ 70 mA for versions with analogue signal

### Total current consumption

≤ 600 mA including switching current

## Accuracy specifications

### Accuracy, analogue signal

≤ ±1.0 % of span

Including non-linearity, hysteresis, zero offset and end value deviation (corresponds to measured error per IEC 61298-2).

### Non-repeatability, analogue signal (IEC 61298-2)

≤ 0.1 % of span

### Long-term drift, analogue signal (IEC 61298-2)

≤ ±0.1 % of span  
≤ ±0.2 % of span for measuring ranges ≤ 0.4 bar [10 psi] and for increased overload safety

### Accuracy, switching output

≤ ±1.0 % of span

### Temperature error in nominal temperature range

maximum: ≤ ±1.5 % of span  
maximum: ≤ ±2.5 % of span with increased overload safety

### Temperature coefficients in nominal temperature range

Mean TC zero point: ≤ ±0.16 % of span/10 K  
Mean TC span: ≤ ±0.16 % of span/10 K

## Reference conditions (per IEC 61298-1)

Temperature: 15 ... 25 °C [59 ... 77 °F]  
Atmospheric pressure: 860 ... 1,060 mbar [12.5 ... 15.4 psi]  
Air humidity: 45 ... 75 % r. h.  
Nominal position: Process connection lower mount  
Power supply: DC 24 V  
Load: see "Output signal"

## Operating conditions

### Permissible temperature ranges

	Standard	Option
Medium	-25 ... +85 °C [-13 ... +185 °F]	-40 ... +125 °C [-40 ... +257 °F) <sup>1)</sup>
Ambient	-20 ... +85 °C [-4 ... +185 °F]	
Storage	-40 ... +70 °C [-40 ... +158 °F]	
Nominal temperature	-20 ... +80 °C [-4 ... +176 °F]	

1) Medium temperature restricted to -30 ... +85 °C [-22 ... +185 °F] with UL approval

### Air humidity

45 ... 75 % r. h.

### Vibration resistance

20 g, 10 ... 2,000 Hz (IEC 60068-2-6, under resonance)

### Shock resistance

50 g, 11 ms (IEC 60068-2-27, mechanical)

### Service life

100 million load cycles

### Ingress protection (per IEC 60529)

IP65 and IP67

The stated ingress protection only applies when plugged in using mating connectors that have the appropriate ingress protection.

### Mounting position

as required

## Materials

### Wetted parts

< 10 bar [150 psi]: 316L  
 ≥ 10 bar [150 psi]: 316L, PH grade steel

### Non-wetted parts

Case: 304L  
 Keyboard: PBT  
 Display window: PC  
 Display head: PBT+PC blend

Pressure transmission fluid:

Synthetic oil for all gauge pressure measuring ranges  
 < 10 bar [150 psi] <sup>1)</sup> and all absolute pressure measuring ranges

<sup>1)</sup> < 16 bar [250 psi] with increased overload safety

### Options for specific media

- Oil and grease free: Residual hydrocarbon: < 1,000 mg/m<sup>2</sup>
- Oxygen, oil and grease free:  
 Residual hydrocarbon: < 200 mg/m<sup>2</sup>  
 Packaging: Protection cap on the process connection, instrument sealed in a vacuum bag  
 Max. permissible temperature -20 ... +60 °C  
 [-4 ... +140 °F]  
 Available measuring ranges:  
 0 ... 400 mbar to 0 ... 400 bar [0 ... 10 to 0 ... 5,000 psi]  
 -1 ... 0 to -1 ... 24 bar [-14.5 ... 0 to -14.5 ... 300 psi]  
 Factory supplied without sealing  
 Available process connections, see "Process connections"

## Process connection

Standard	Thread size	Max. nominal pressure	Sealing
DIN EN ISO 1179-2 (formerly DIN 3852-E)	G ¼ A	600 bar [8,700 psi]	NBR (options: Without, FPM/FKM)
	G ½ A	400 bar [5,800 psi]	NBR (options: Without, FPM/FKM)
EN 837	G ¼ B <sup>1)</sup>	1,000 bar [14,500 psi]	Without (options: Copper, stainless steel)
	G ¼ female <sup>1)</sup>	1,000 bar [14,500 psi]	Without (option: Copper, stainless steel)
	G ½ B <sup>1)</sup>	1,000 bar [14,500 psi]	Without (options: Copper, stainless steel)
ANSI/ASME B1.20.1	¼ NPT <sup>1)</sup>	1,000 bar [14,500 psi]	-
	½ NPT <sup>1)</sup>	1,000 bar [14,500 psi]	-
ISO 7	R ¼ <sup>1)</sup>	1,000 bar [14,500 psi]	-
KS	PT ¼ <sup>1)</sup>	1,000 bar [14,500 psi]	-
-	G ¼ female (Ermeto compatible)	1,000 bar [14,500 psi]	Without (options: Copper, stainless steel)

<sup>1)</sup> suitable for oxygen, oil and grease free.

Other connections on request.

### Restrictor (option)

For applications where pressure spikes can occur, the use of a restrictor is recommended. The restrictor narrows the pressure port to 0.6 mm and thus increases the resistance against pressure spikes.

### Enlarged pressure port (option)

For applications with contaminated or viscous media, for specific process connections, an enlarged pressure port with a 6 or 12 mm diameter is available in order to reduce the risk of a pressure port blocking.

## Electrical connections

### Connections

- Circular connector M12 x 1 (4-pin)
- Circular connector M12 x 1 (5-pin) <sup>1)</sup>

1) Only for version with two switching outputs and additional analogue signal

### Electrical safety

Short-circuit resistance: S+ / SP1 / SP2 vs. U-

Reverse polarity protection: U+ vs. U-

Insulation voltage: DC 500 V

Overvoltage protection: DC 36 V

### Connection diagrams

#### Circular connector M12 x 1 (4-pin)

U+	1
U-	3
SP2 / S+	2
SP1 / C	4

#### Circular connector M12 x 1 (5-pin)

U+	1
U-	3
S+	5
SP1 / C	4
SP2	2

### Legend:

- U+ Positive power supply
- U- Negative power supply terminal
- SP1 Switching output 1
- SP2 Switching output 2
- C Communication with IO-Link
- S+ Analogue output

## Dimensions in mm [in]

Pressure switch with circular connector M12 x 1 (4-pin and 5-pin)

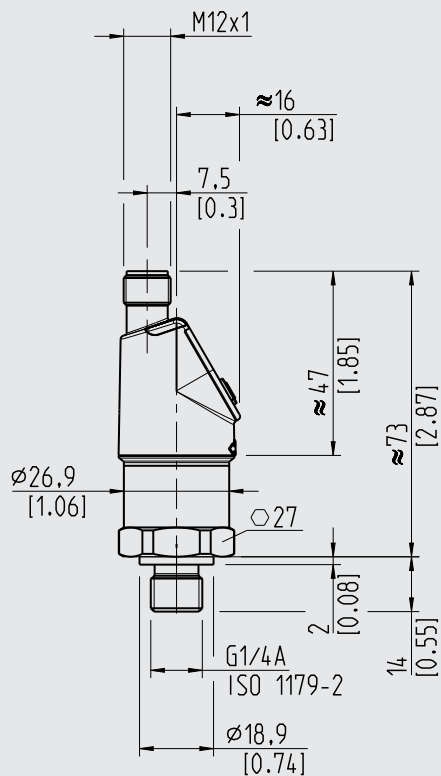

Weight: approx. 90 ... 130 g [3.17 ... 4.59 oz]

DIN EN ISO 1119-2  
(formerly DIN 3852-E)

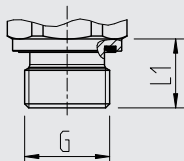

G	L1
G ¼ A	14 [0.55]
G ½ A	17 [0.67]

EN 837

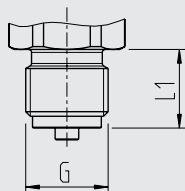

G	L1
G ¼ B	13 [0.51]
G ½ B	20 [0.79]

ANSI/ASME B1.20.1  
KS  
ISO 7

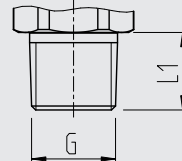

G	L1
¼ NPT	13 [0.51]
½ NPT	19 [0.75]
R ¼	13 [0.51]
PT ¼	13 [0.51]

Female thread

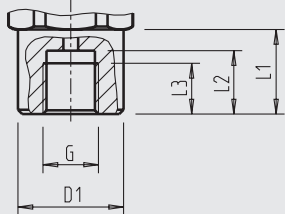

G	L1	L2	L3	D1
G ¼	20 [0.79]	15 [0.59]	12 [0.47]	∅ 25 [0.98]

EN 837, female thread

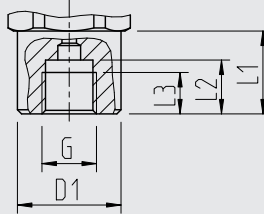



G	L1	L2	L3	D1
G ¼ A	20 [0.79]	13 [0.51]	10 [0.39]	∅ 25 [0.98]

Ermeto compatible

## Accessories and spare parts

Sealings		
	Description	Order number
	NBR profile sealing G ¼ A DIN EN ISO 1179-2 (formerly DIN 3852-E)	1537857
	FPM/FKM profile sealing G ¼ A DIN EN ISO 1179-2 (formerly DIN 3852-E)	1576534
	NBR profile sealing G ½ A DIN EN ISO 1179-2 (formerly DIN 3852-E)	1039067
	FPM/FKM profile sealing G ½ A DIN EN ISO 1179-2 (formerly DIN 3852-E)	1039075
	Copper G ¼ B EN 837	11250810
	Stainless steel G ¼ B EN 837	11250844
	Copper G ½ B EN 837	11250861
	Stainless steel G ½ B EN 837	11251042

Connectors with moulded cable				
	Description	Temperature range	Cable diameter	Order number
	Straight version, cut to length, 4-pin, 2 m [6.6 ft] PUR cable, UL listed, IP67	-20 ... +80 °C [-4 ... 176 °F]	4.5 mm [0.18 in]	14086880
	Straight version, cut to length, 4-pin, 5 m [16.4 ft] PUR cable, UL listed, IP67	-20 ... +80 °C [-4 ... 176 °F]	4.5 mm [0.18 in]	14086883
	Straight version, cut to length, 4-pin, 10 m [32.8 ft] PUR cable, UL listed, IP67	-20 ... +80 °C [-4 ... 176 °F]	4.5 mm [0.18 in]	14086884
	Straight version, cut to length, 5-pin, 2 m [6.6 ft] PUR cable, UL listed, IP67	-20 ... +80 °C [-4 ... 176 °F]	5.5 mm [0.22 in]	14086886
	Straight version, cut to length, 5-pin, 5 m [16.4 ft] PUR cable, UL listed, IP67	-20 ... +80 °C [-4 ... 176 °F]	5.5 mm [0.22 in]	14086887
	Straight version, cut to length, 5-pin, 10 m [32.8 ft] PUR cable, UL listed, IP67	-20 ... +80 °C [-4 ... 176 °F]	5.5 mm [0.22 in]	14086888
	Angled version, cut to length, 4-pin, 2 m [6.6 ft] PUR cable, UL listed, IP67	-20 ... +80 °C [-4 ... 176 °F]	4.5 mm [0.18 in]	14086889
	Angled version, cut to length, 4-pin, 5 m [16.4 ft] PUR cable, UL listed, IP67	-20 ... +80 °C [-4 ... 176 °F]	4.5 mm [0.18 in]	14086891
	Angled version, cut to length, 4-pin, 10 m [32.8 ft] PUR cable, UL listed, IP67	-20 ... +80 °C [-4 ... 176 °F]	4.5 mm [0.18 in]	14086892
	Angled version, cut to length, 5-pin, 2 m [6.6 ft] PUR cable, UL listed, IP67	-20 ... +80 °C [-4 ... 176 °F]	5.5 mm [0.22 in]	14086893
	Angled version, cut to length, 5-pin, 5 m [16.4 ft] PUR cable, UL listed, IP67	-20 ... +80 °C [-4 ... 176 °F]	5.5 mm [0.22 in]	14086894
	Angled version, cut to length, 5-pin, 10 m [32.8 ft] PUR cable, UL listed, IP67	-20 ... +80 °C [-4 ... 176 °F]	5.5 mm [0.22 in]	14086896



## Approvals

Logo	Description	Country
	<b>EU declaration of conformity</b> <ul style="list-style-type: none"> <li>■ EMC directive</li> <li>■ Pressure equipment directive</li> <li>■ RoHS directive</li> </ul>	European Union
	<b>UL</b> Safety (e.g. electr. safety, overpressure, ...)	USA and Canada

## Manufacturer's information and certificates

Logo	Description
-	<b>China RoHS directive</b>
-	<b>MTTF &gt; 100 years</b>

## Patents, property rights

Protected design, registered under DPMA (German patent and trade mark office) no. 402017001481-0001

Approvals and certificates, see website

## Ordering information

Model / Accuracy / Measuring range / Process connection / Sealing / Medium temperature / Output signal / Options for special media and overload safety

© 07/2019 WIKA Alexander Wiegand SE & Co. KG, all rights reserved.  
 The specifications given in this document represent the state of engineering at the time of publishing.  
 We reserve the right to make modifications to the specifications and materials.

